

MONTAGEANLEITUNG
INSTRUKCJA MONTAŻU
FITTING-UP INSTRUCTION
ІНСТРУКЦІЯ МОНТАЖУ
ИНСТРУКЦИЯ СБОРКИ

MONTÁŽNY NÁVOD
INSTRUCTIONS POUR LE MONTAGE
INSTRUCCIONES DE MONTAJE
SZERELÉSI ÚTMUTATÓ
UPUTE ZA SASTAVLJANJE

Notwendiges Montagewerkzeug:
Do montażu potrzebne są:
You need for fitting-up:
Для монтажу потрібні:
Для сборки нужны:

Pour le montage il faut:
Para realizar el montaje es necesario:
K montá i potrebuje:
A szereléshez szükséges:
Za sastavljanje su potrebne:

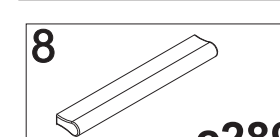
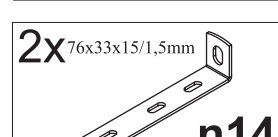
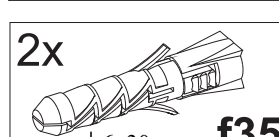
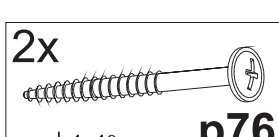
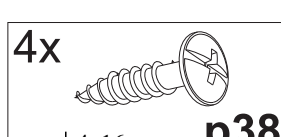
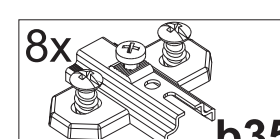
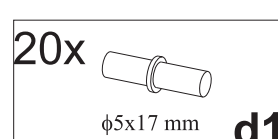
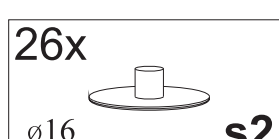
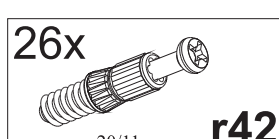
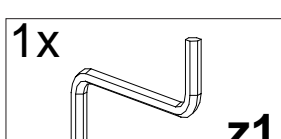
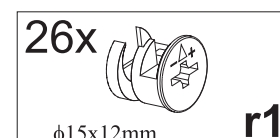
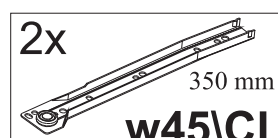
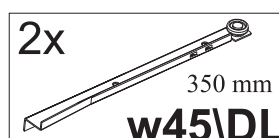
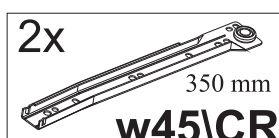
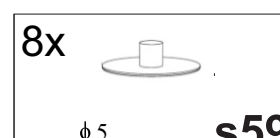
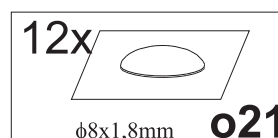
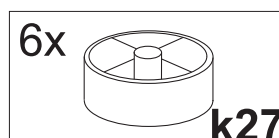
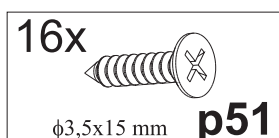
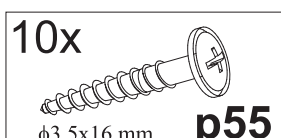
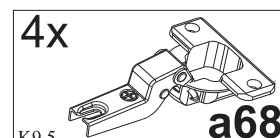
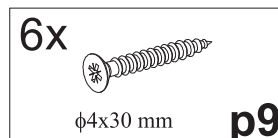
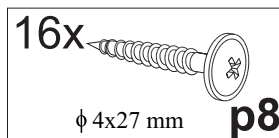
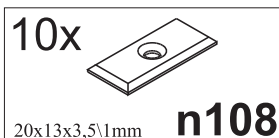
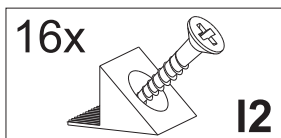
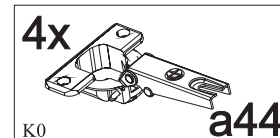
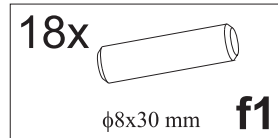
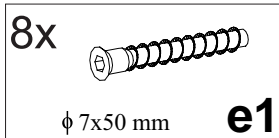
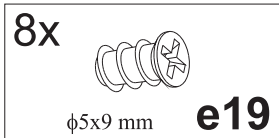
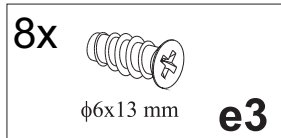
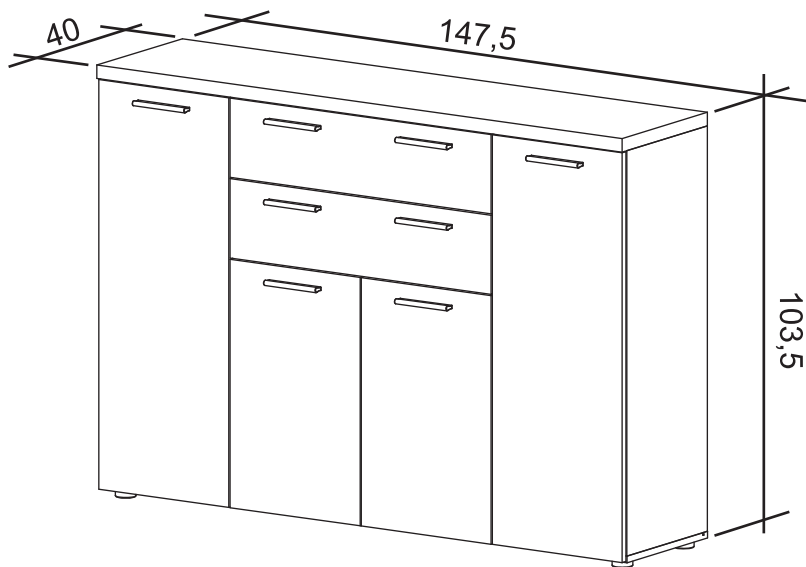
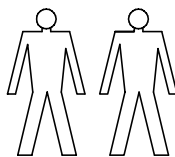
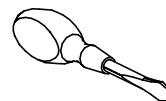
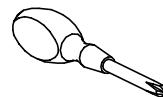
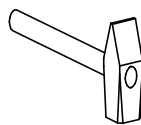
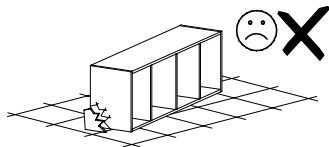
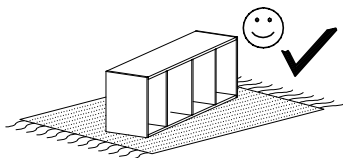

1

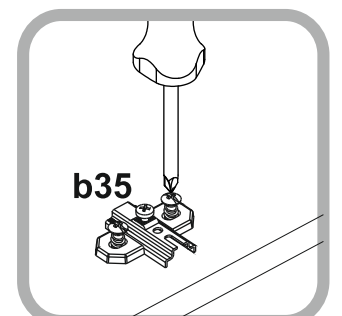
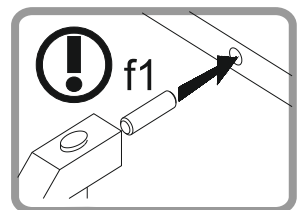
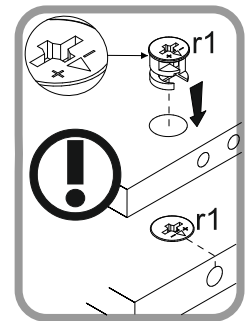
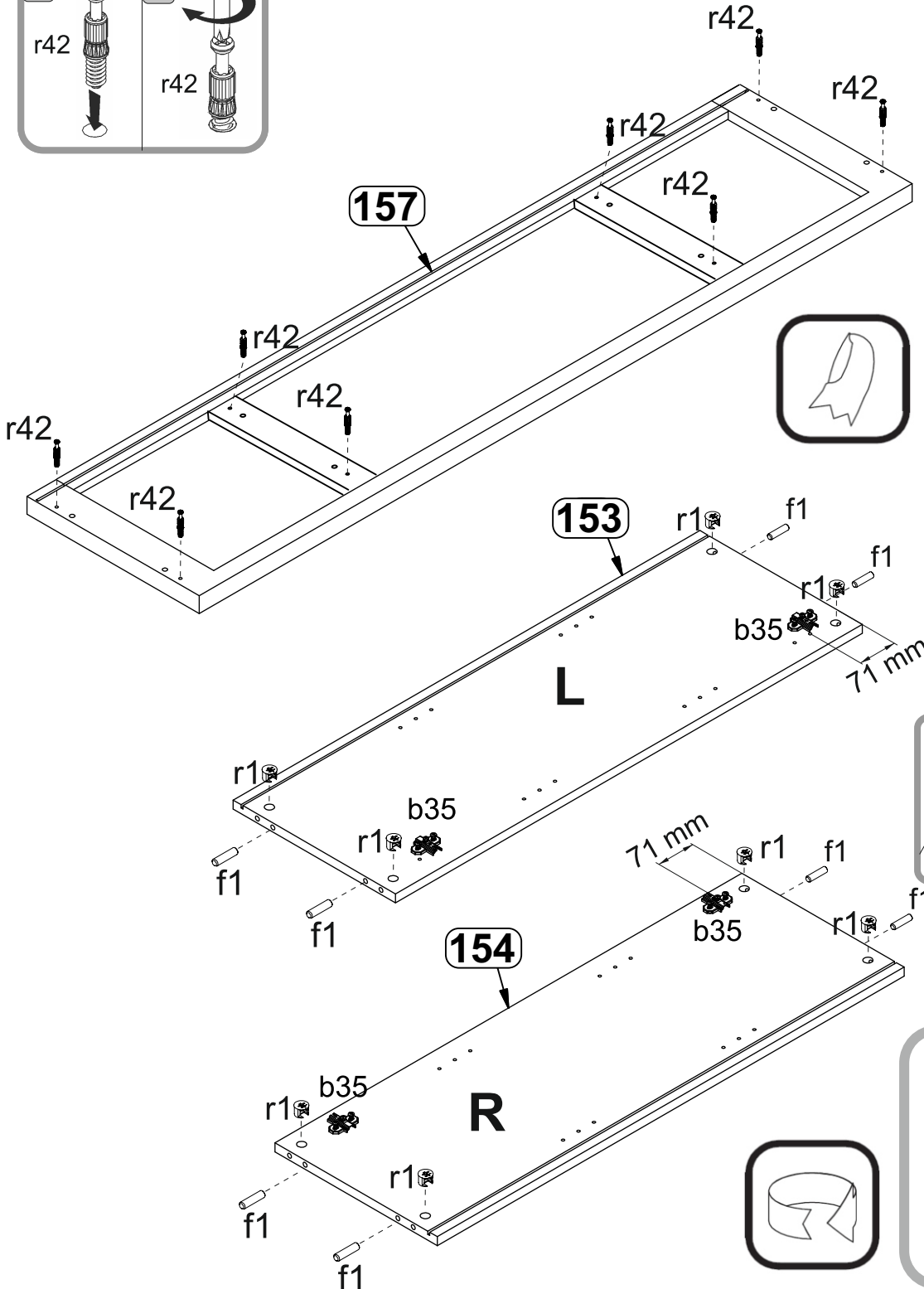
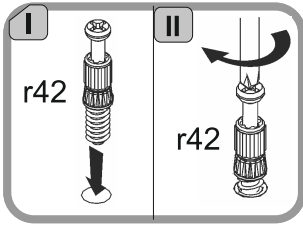
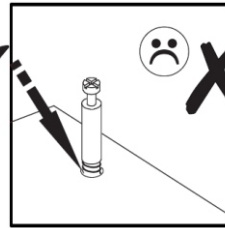
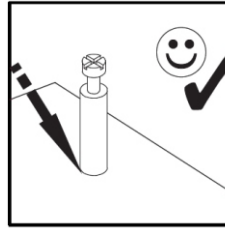
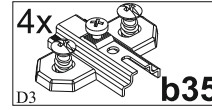
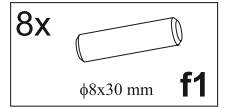
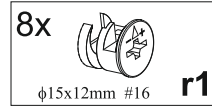
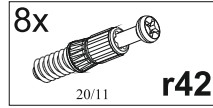
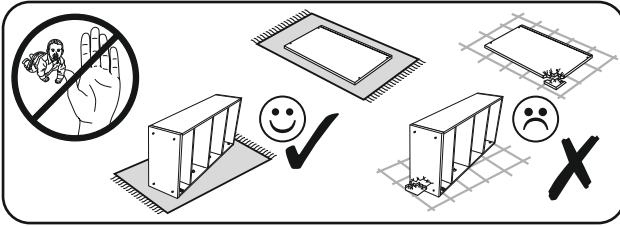

2

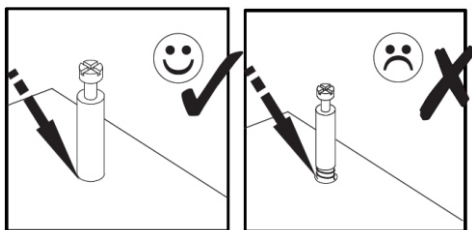
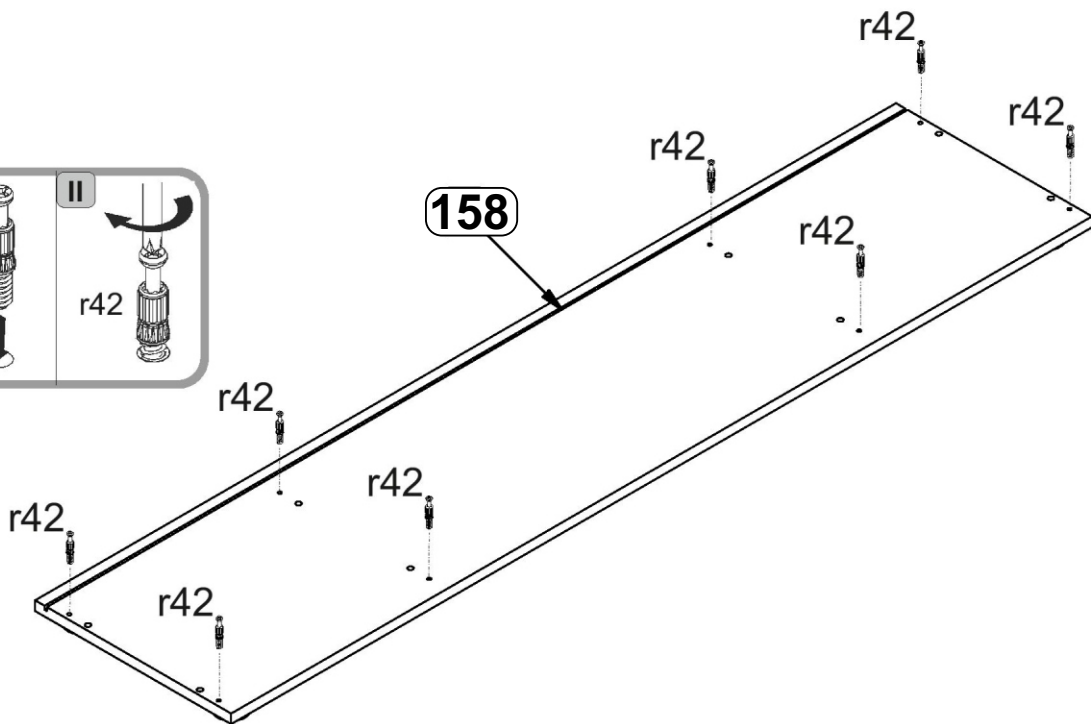
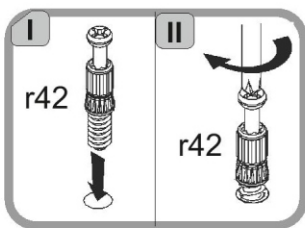
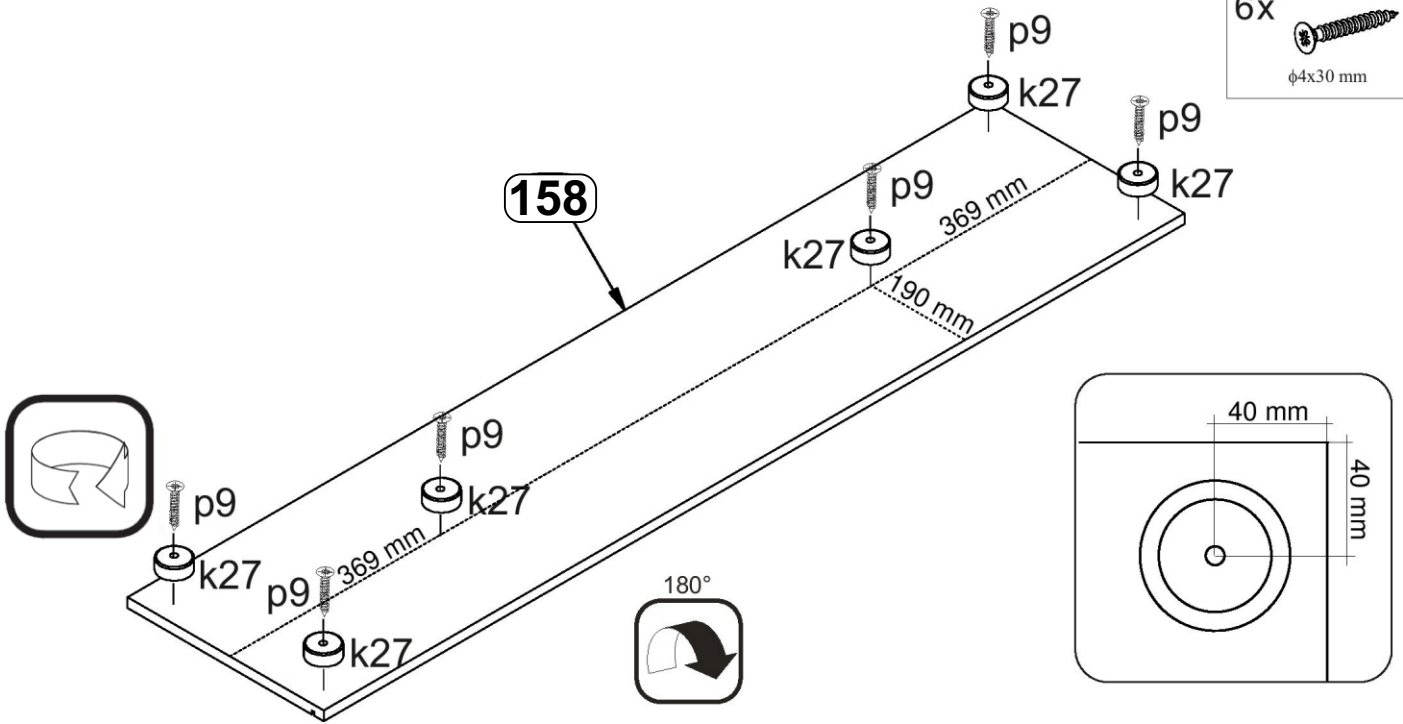
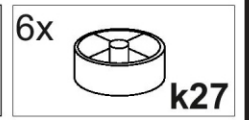
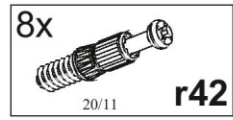

3

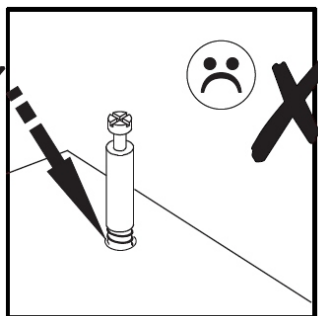
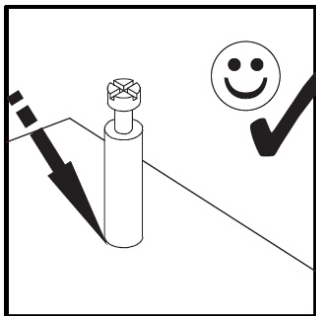
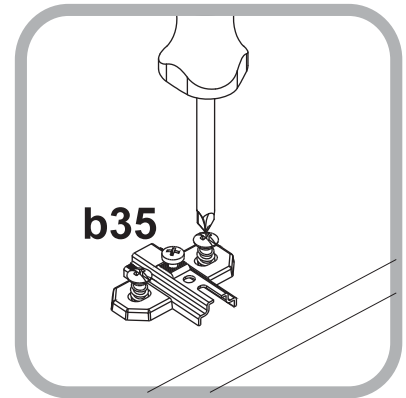
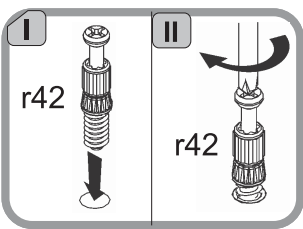
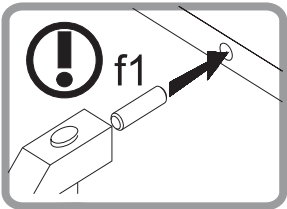
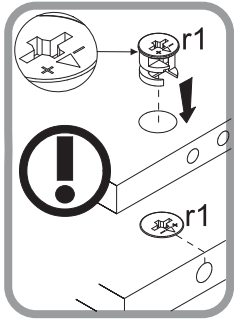
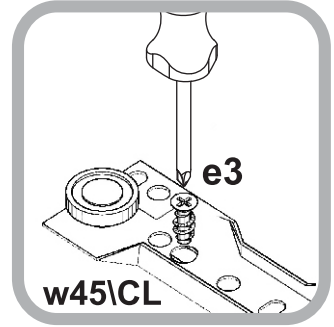
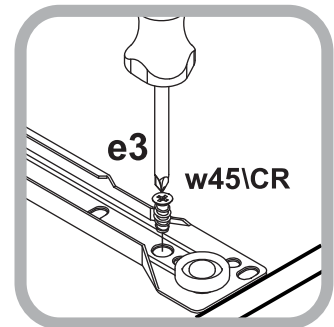
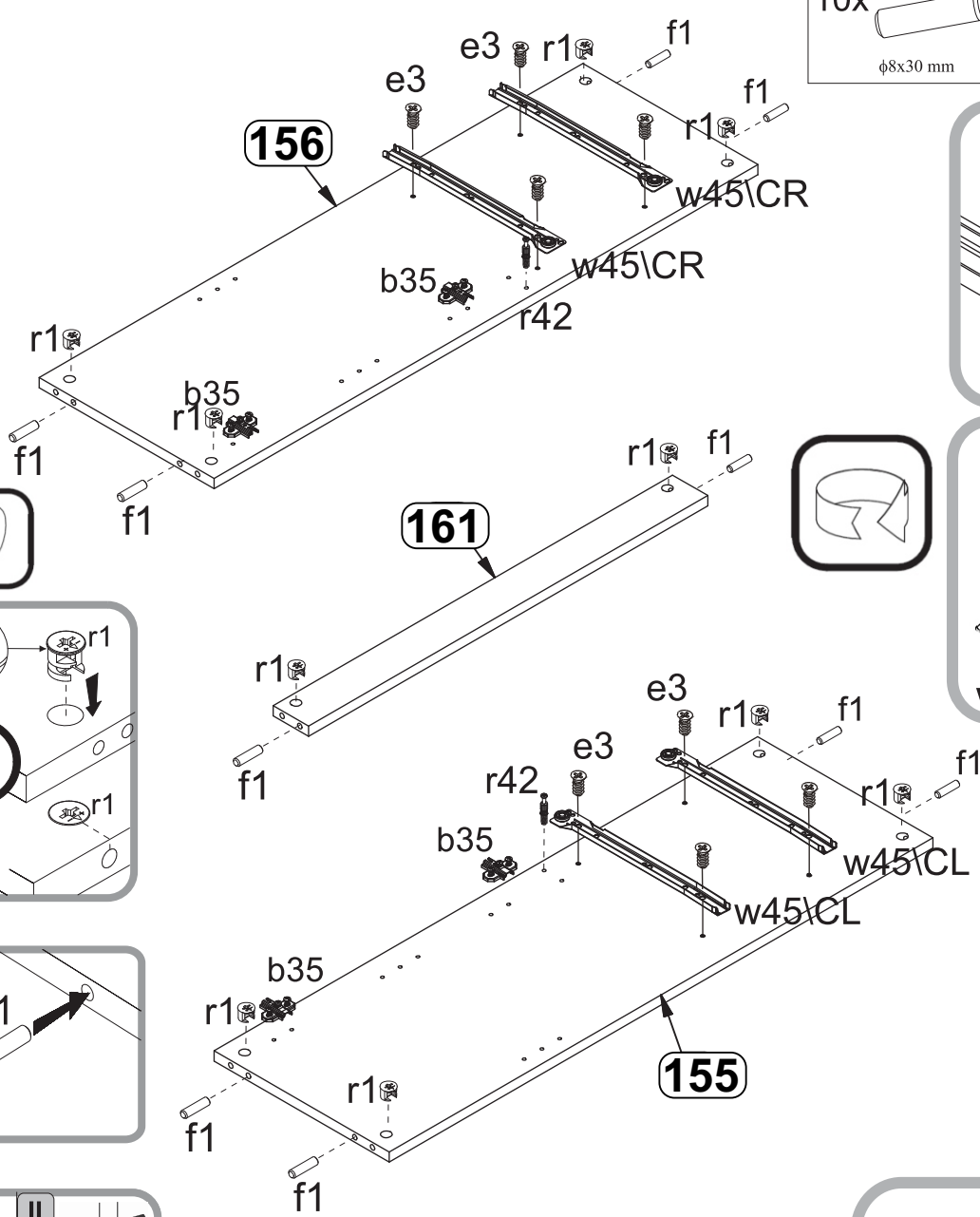
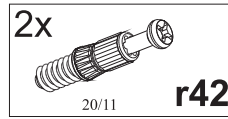
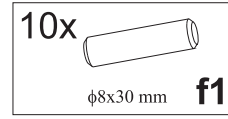
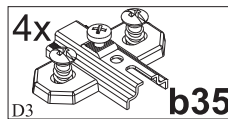
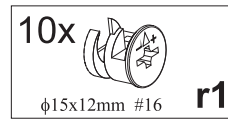
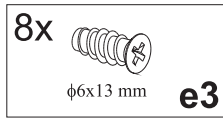
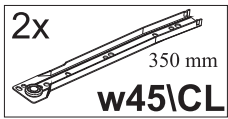
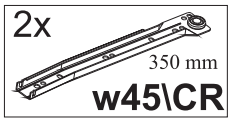

4

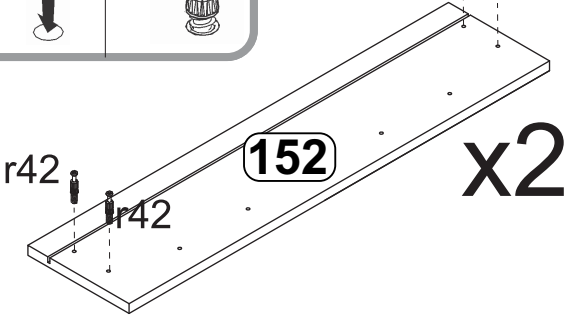
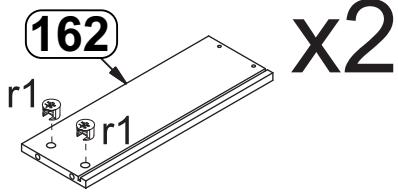
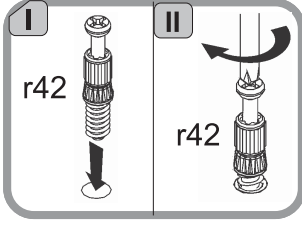
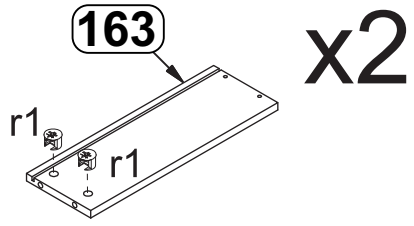
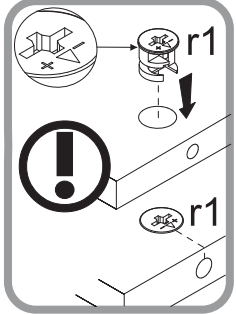
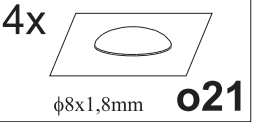
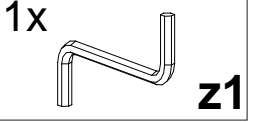
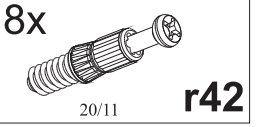
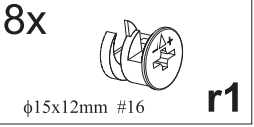
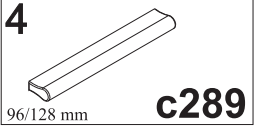
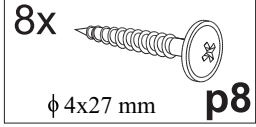
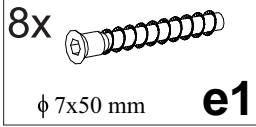

A

x2

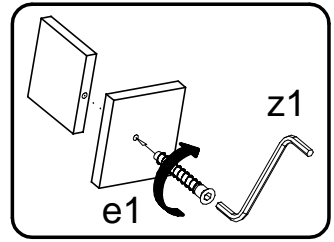
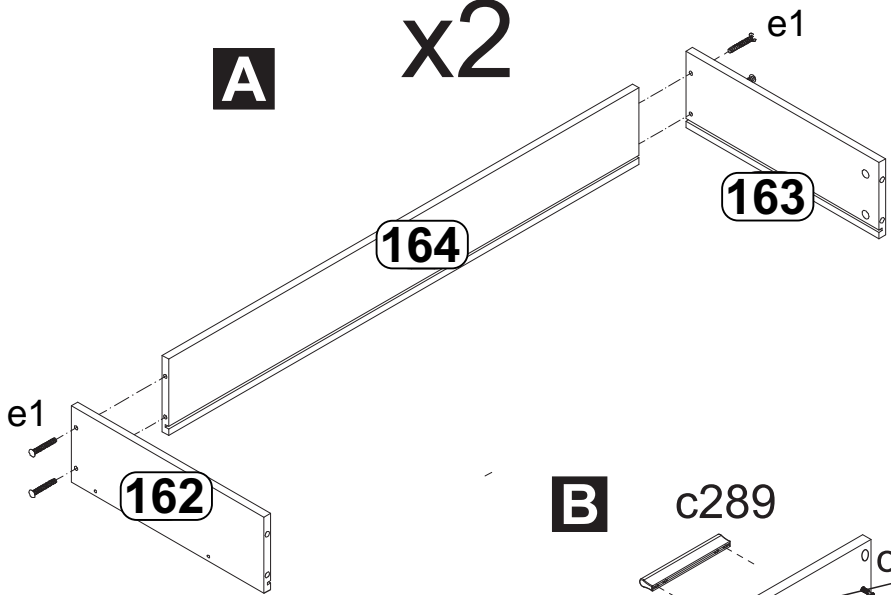

B

x2

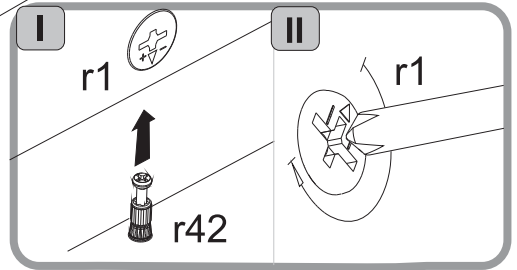
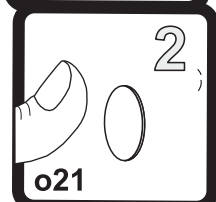
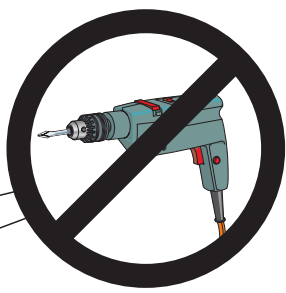
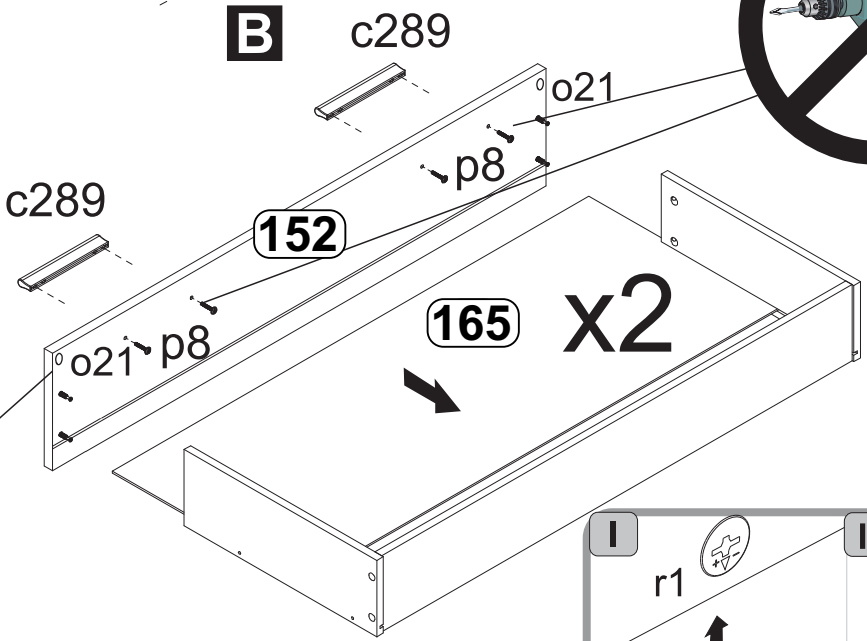

5

8x  $\varnothing 16$ s2

8x  $\phi 5 \times 9$ mm e19

2x  350 mm w45\DL

2x  350 mm w45\DR

x2

C

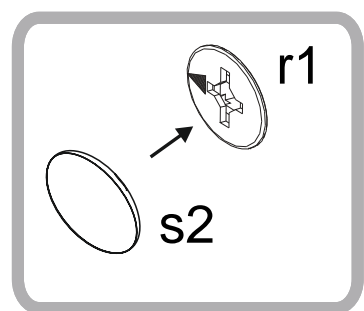
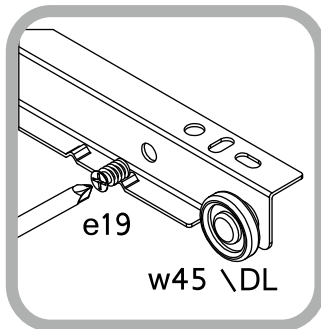
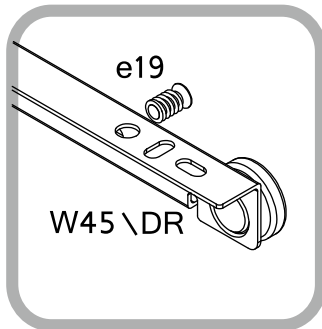
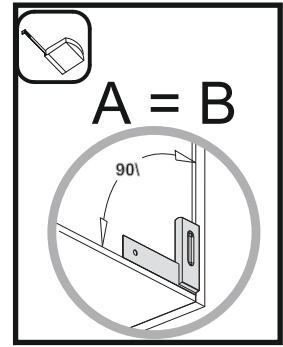
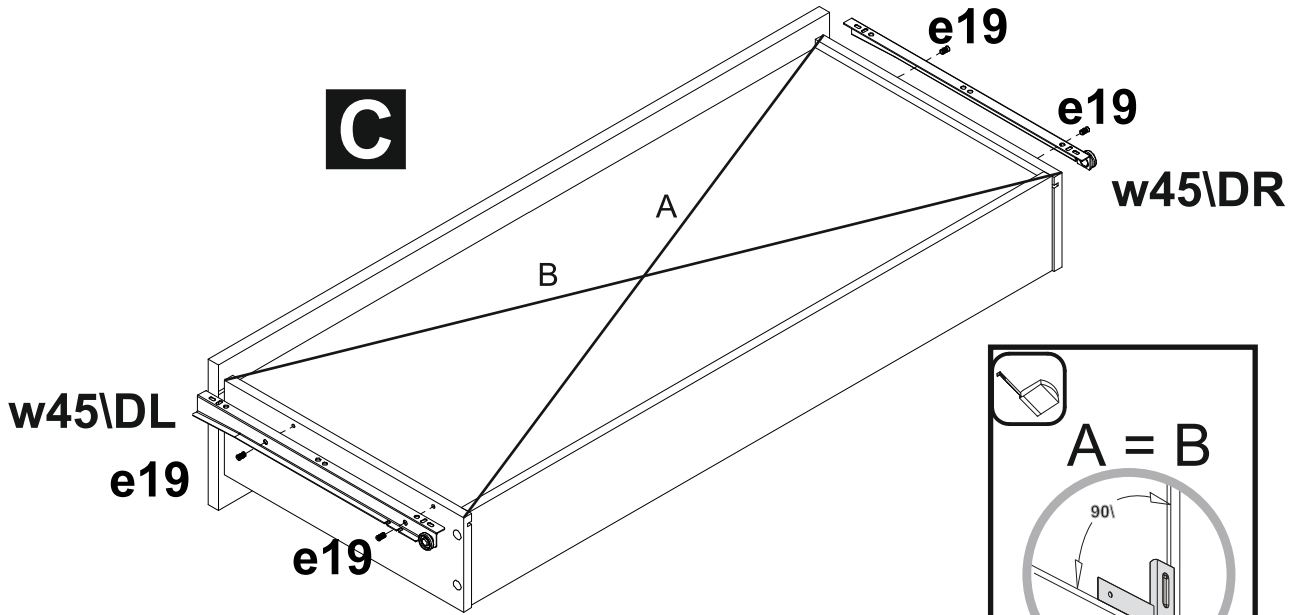

6

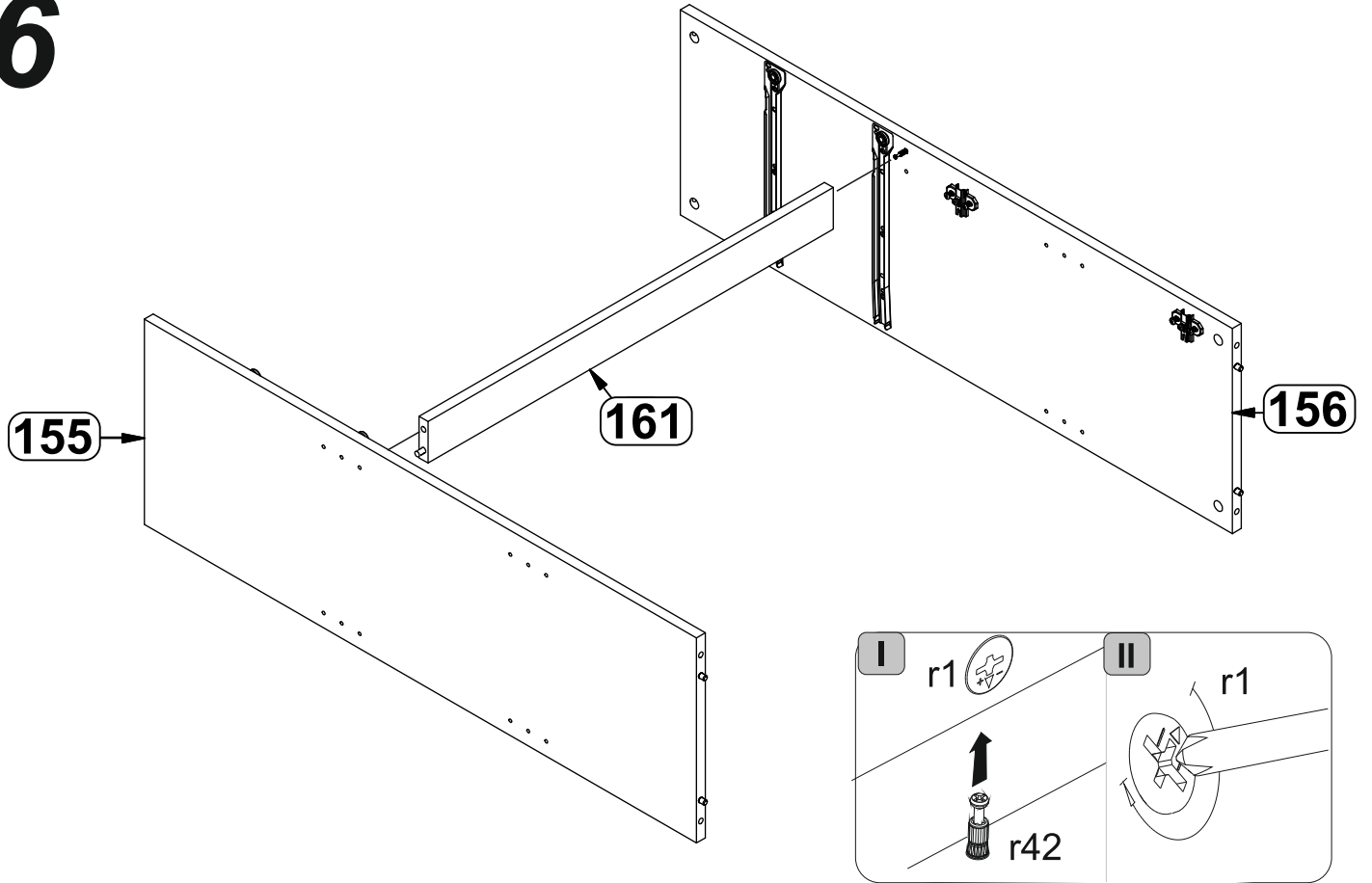

7

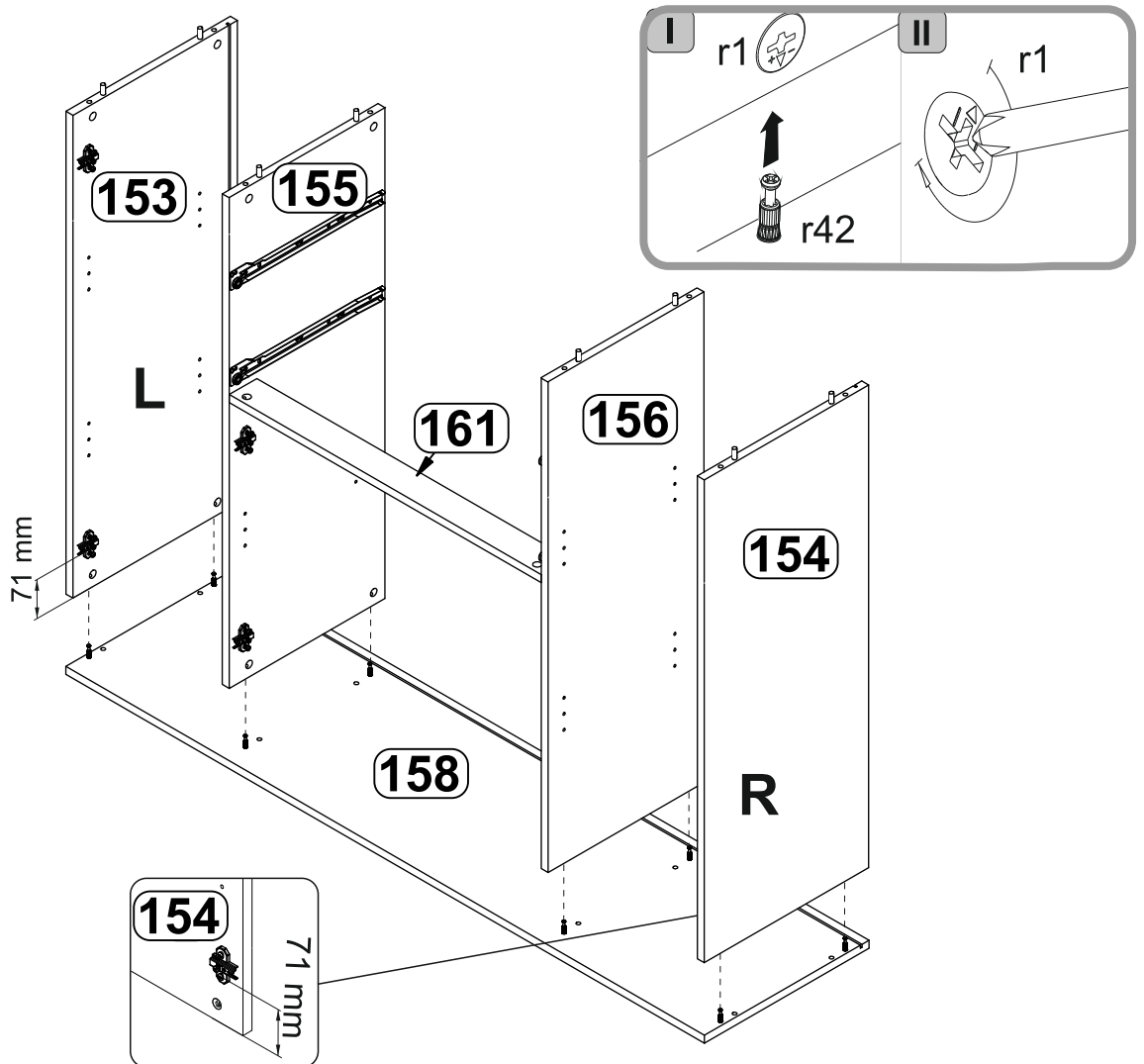

8

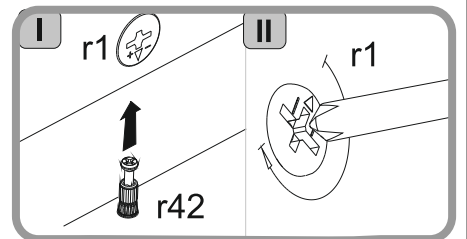
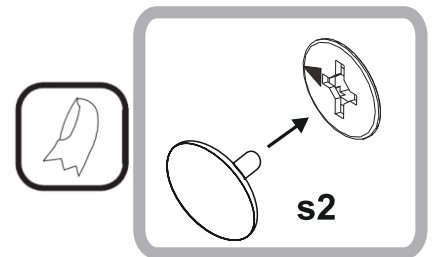
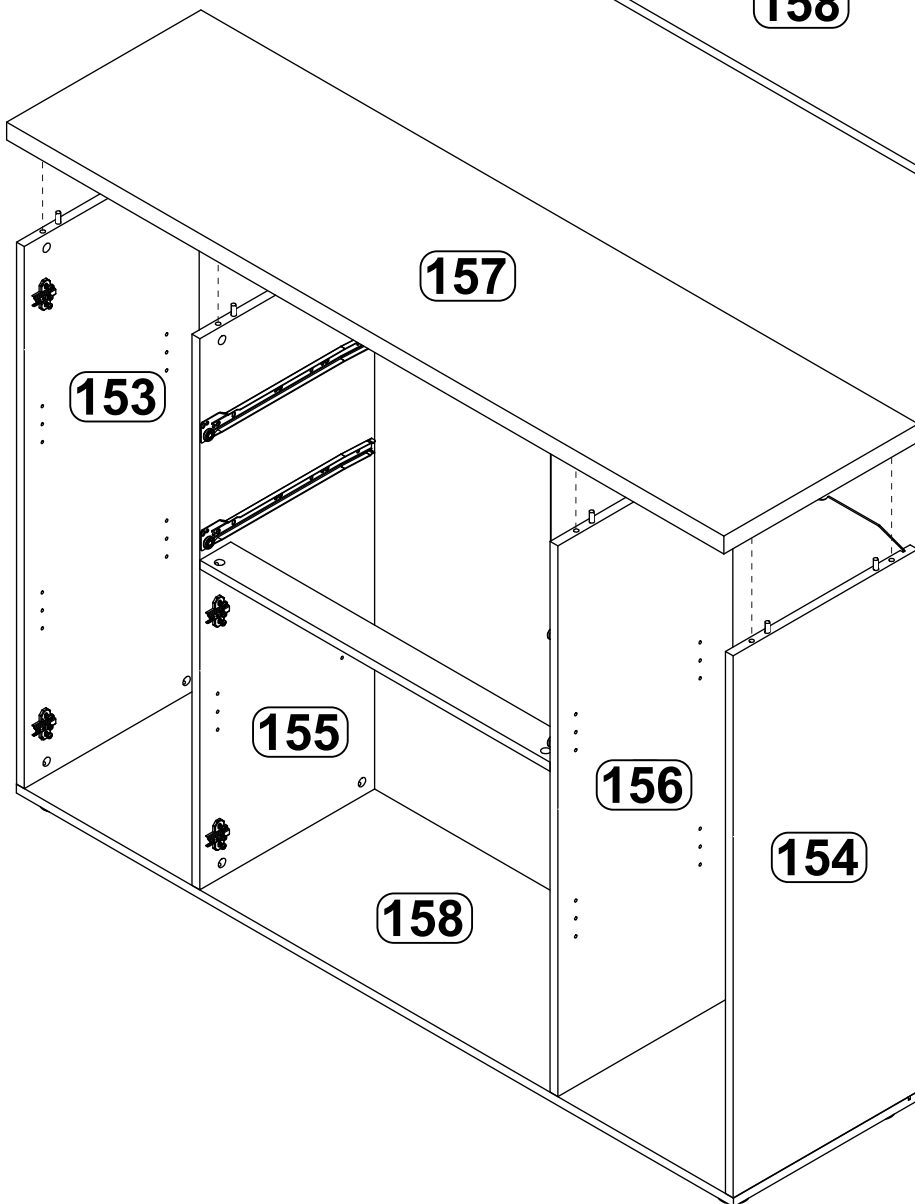
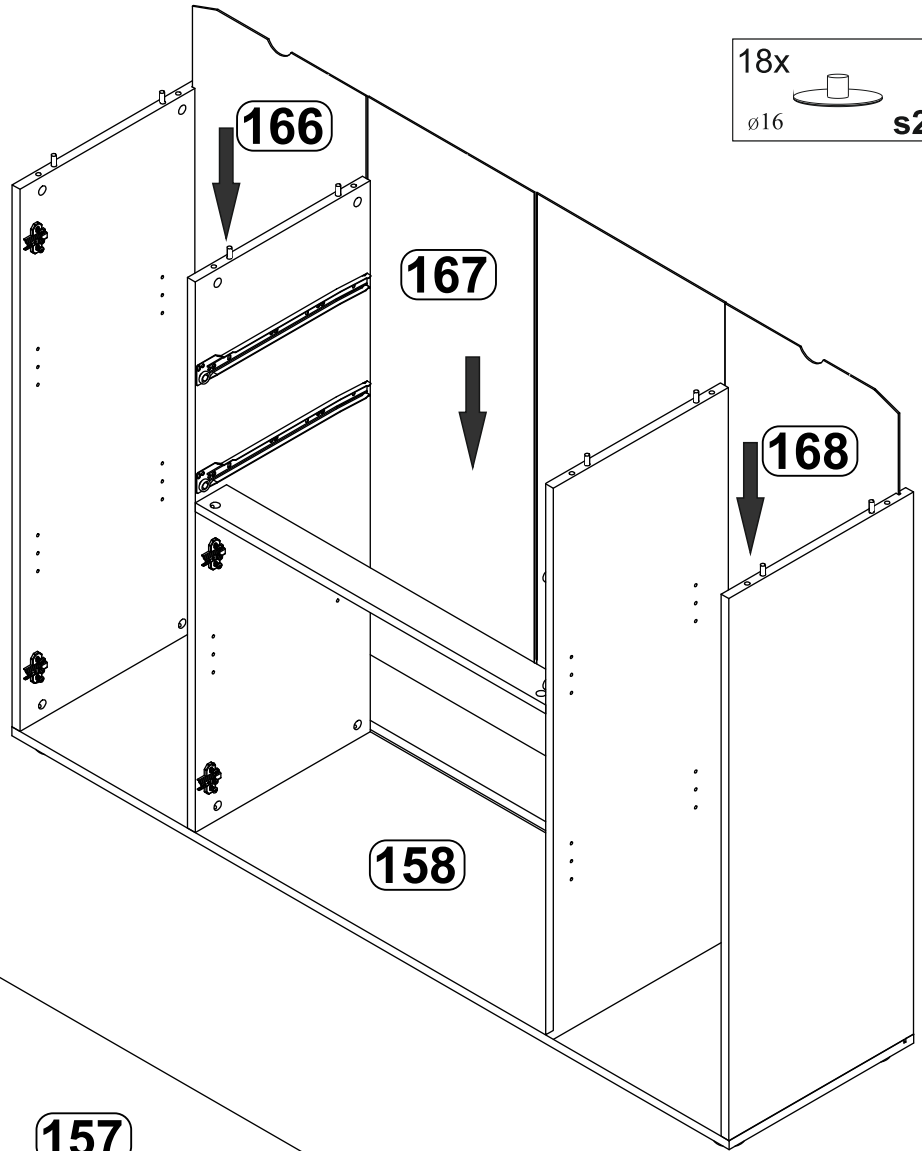

9

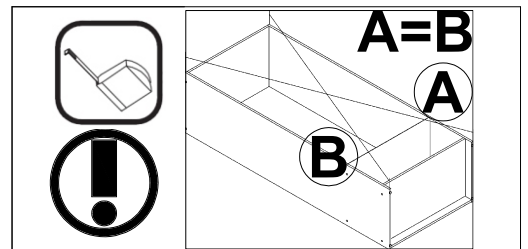
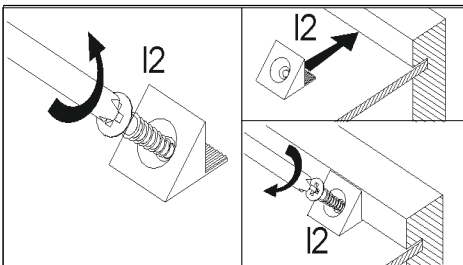
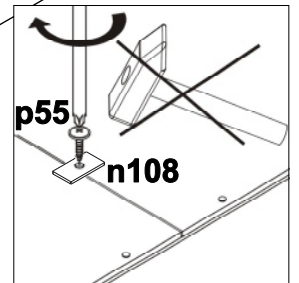
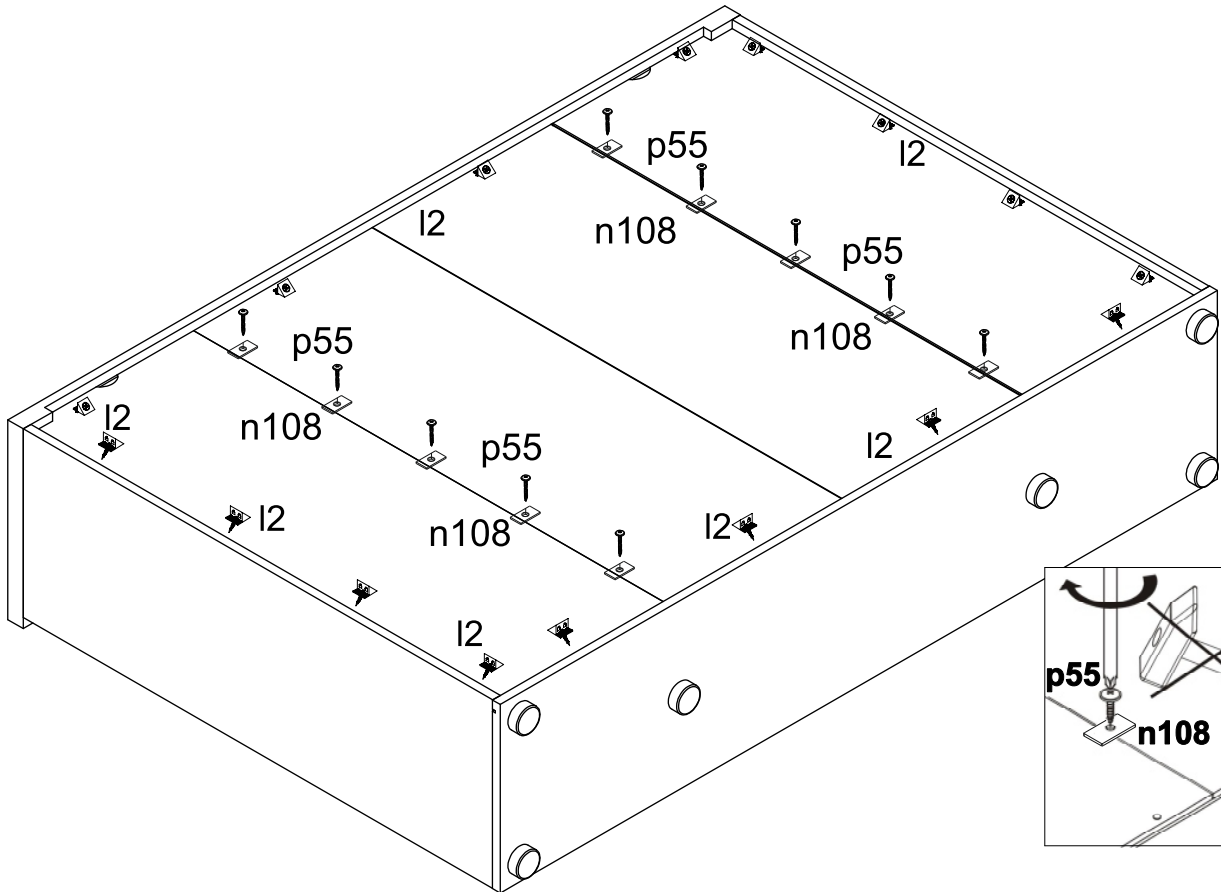
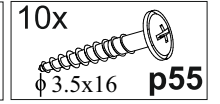
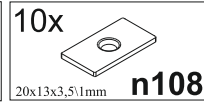
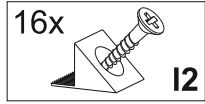

10

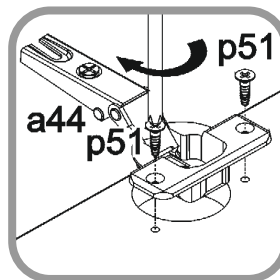
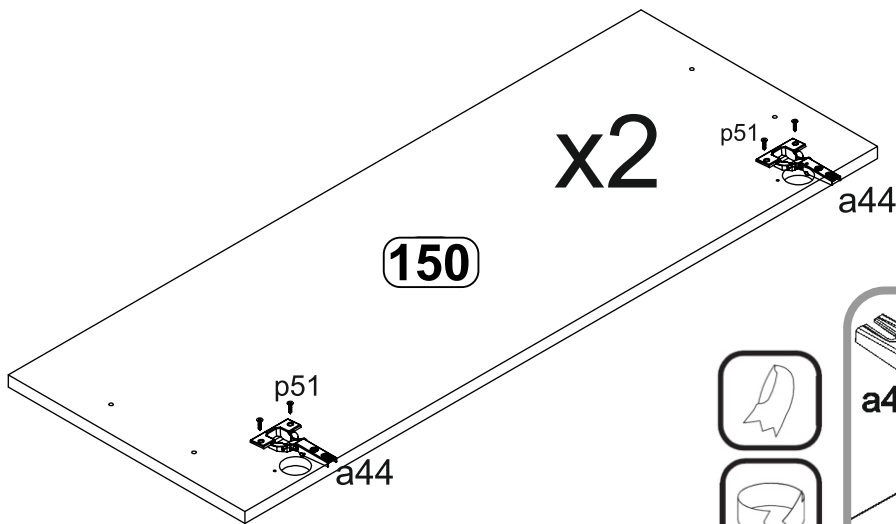
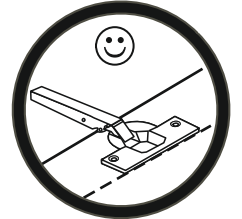
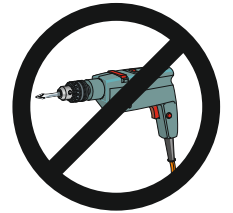
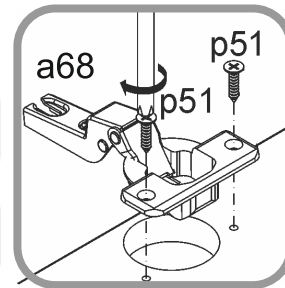
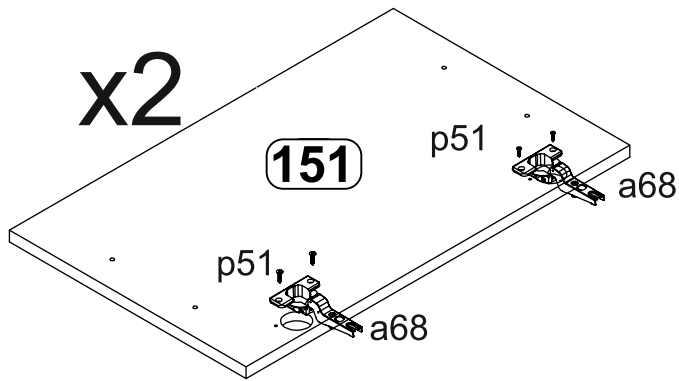
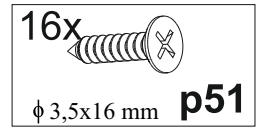
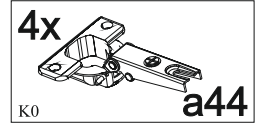
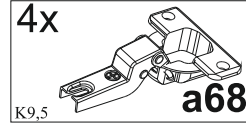
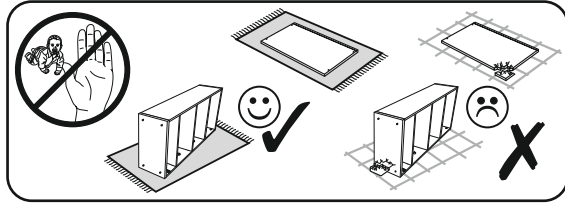

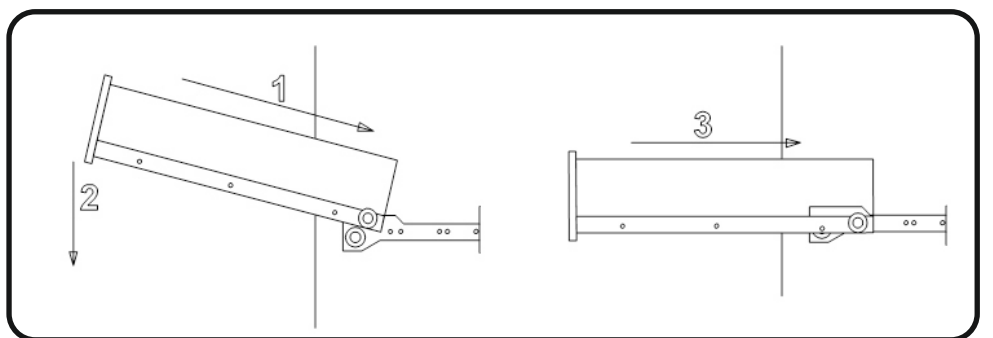
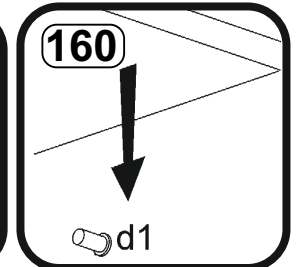
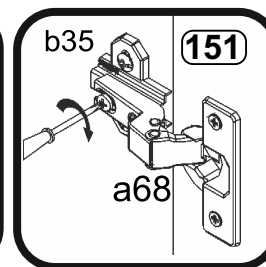
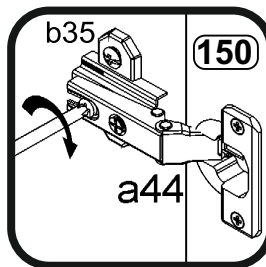
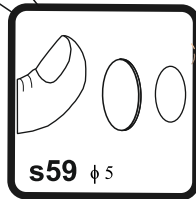
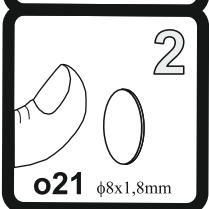
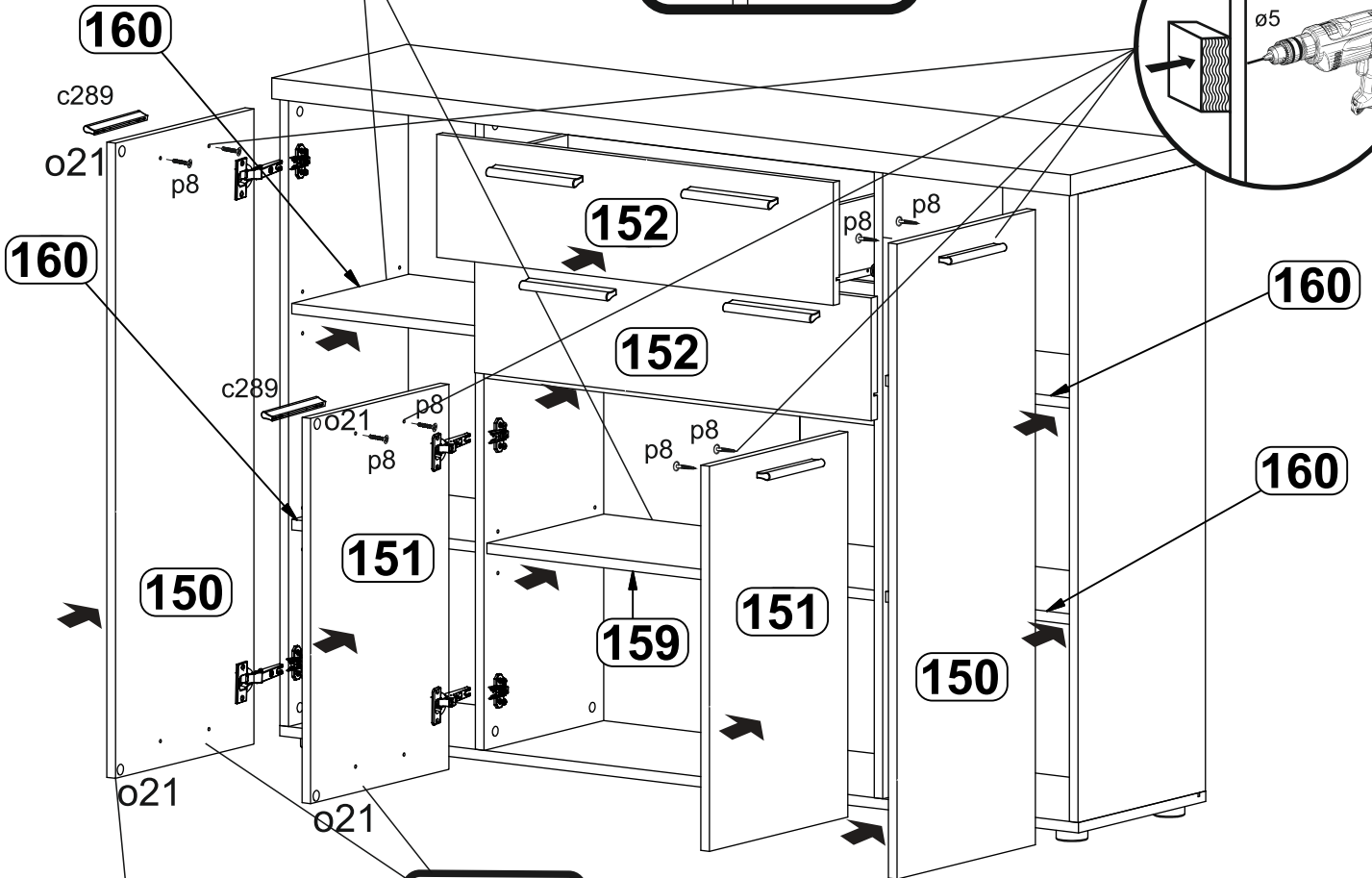
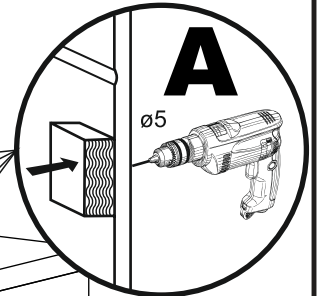
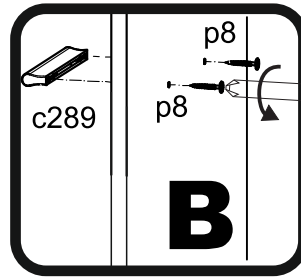
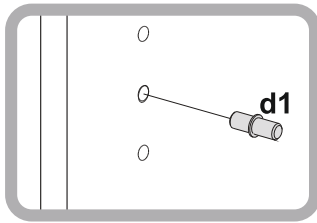
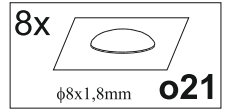
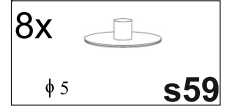
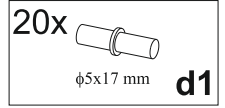
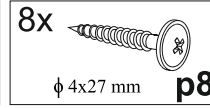
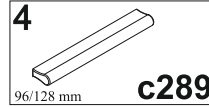

11

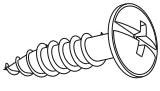

12

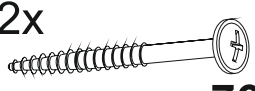
4x

φ 4x16 mm **p38**

2x

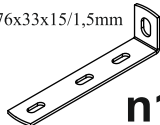
φ 4x40 mm **p76**

2x

φ 6x30 mm **f35**

2x ^{76x33x15/1,5mm}

n14

