



(D) AUFBAUANLEITUNG

(GB) ASSEMBLY INSTRUCTIONS

(NL) HANDLEIDING VOOR DE MONTAGE

(PL) INSTRUKCJA MONTAŻU

(TR) MONTAJ TALIMATI

(RU) Инструкция по монтажу

2F-OTM/BK (2-OTM)

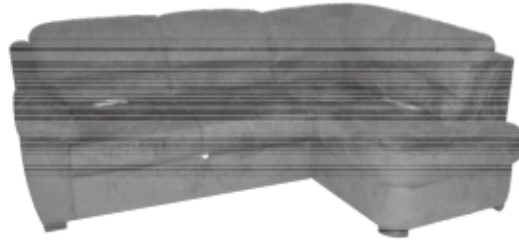

Service • Dienstverlening • Serwis • Servis • Сервисная служба

Name • Naam • Nazwa • İsim • Название

Nr. • No. • Номер

Typ • Type • Tip • Тип

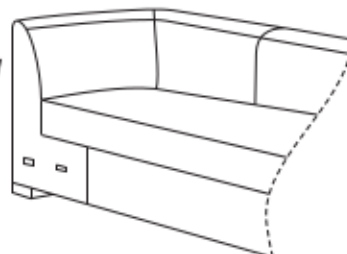
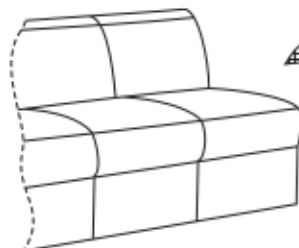
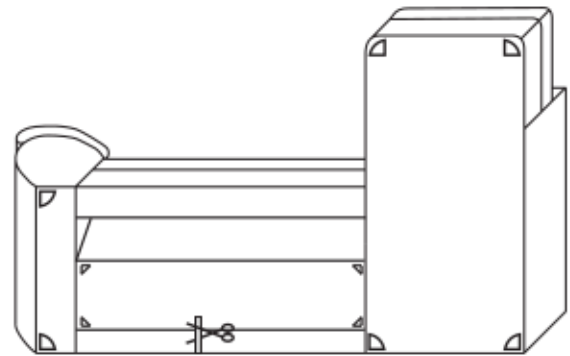
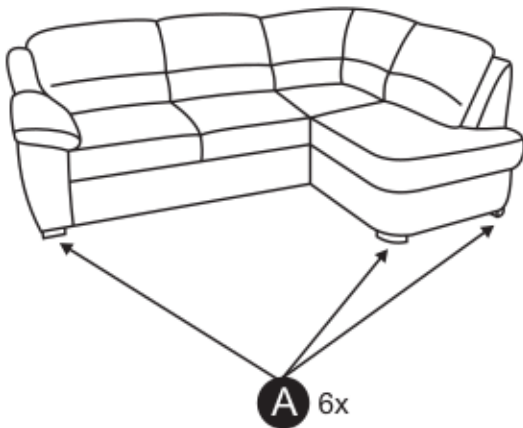
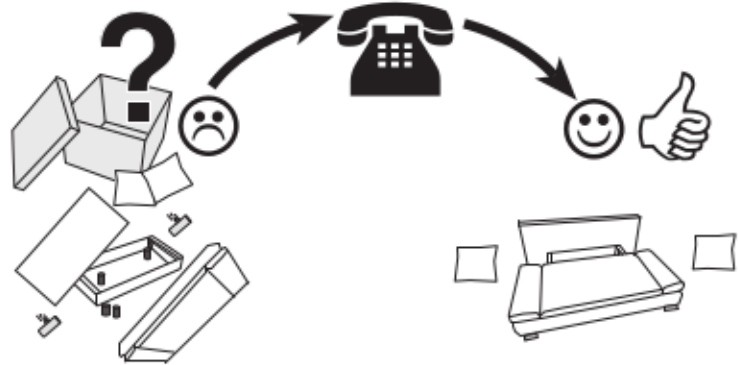
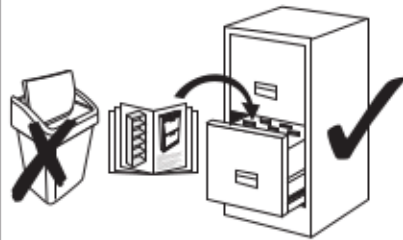

0
10
20
30
40
50
60
70
80
90
100
110
120
130
140
150
160
170
180
190
200