

RM 5

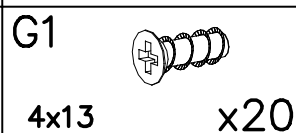

I

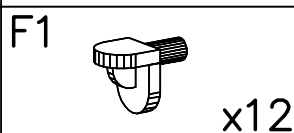
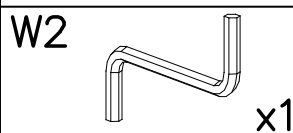
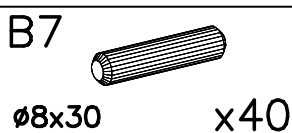
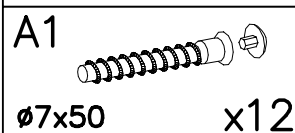
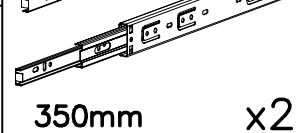
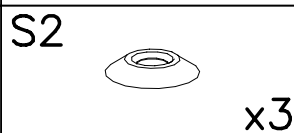
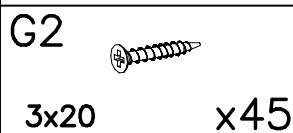
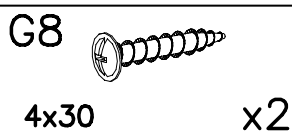
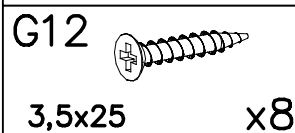
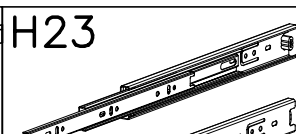
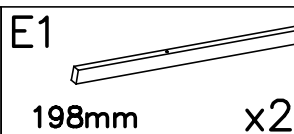
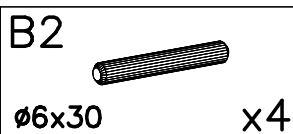
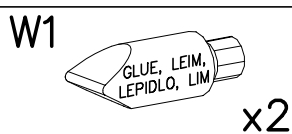
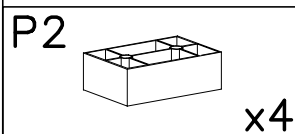
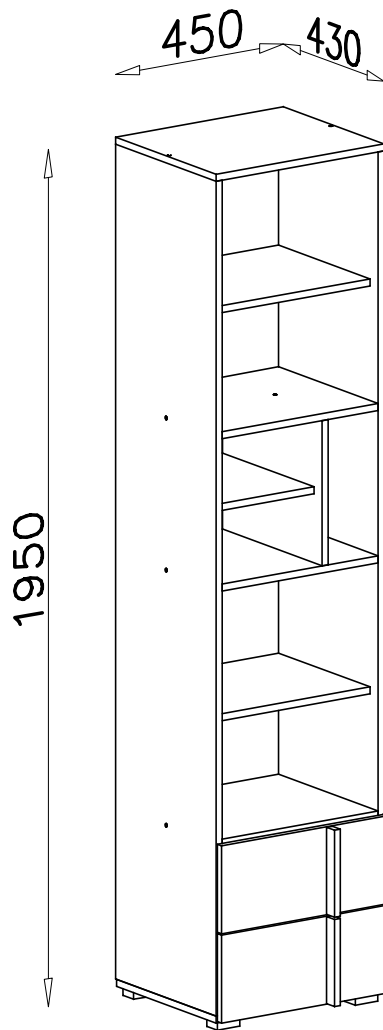
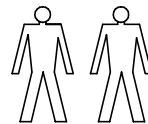
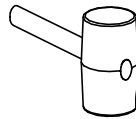
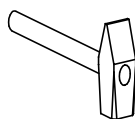
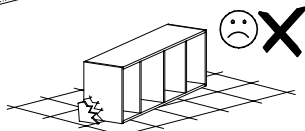
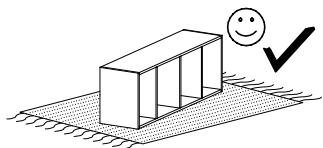
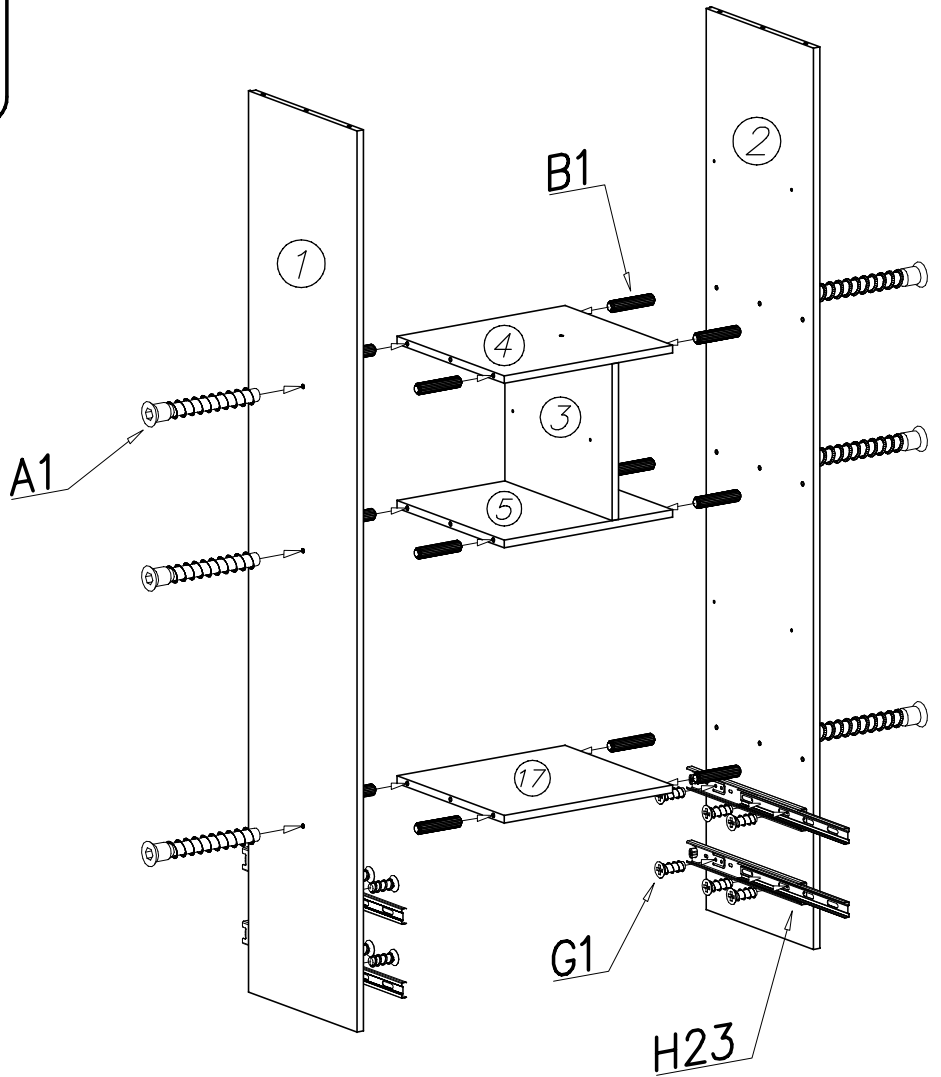
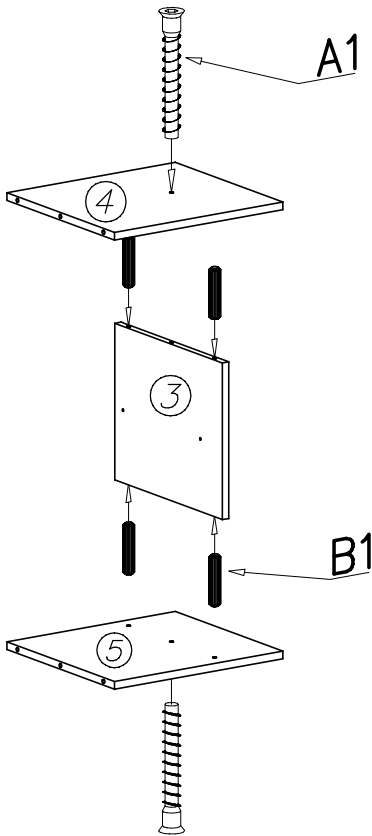
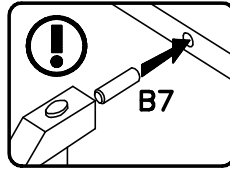
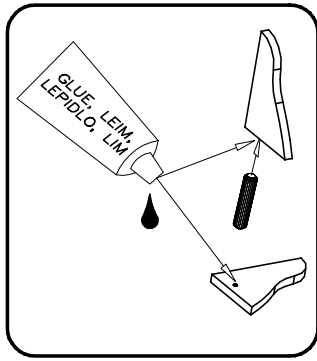

A

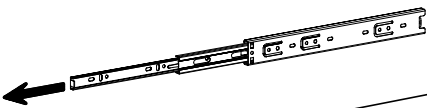

B

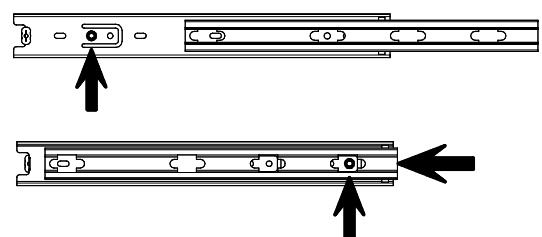
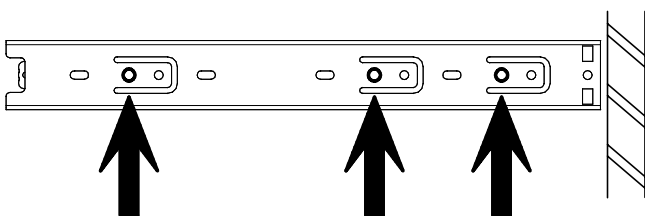
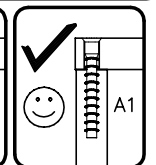
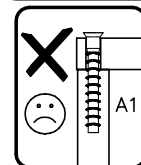
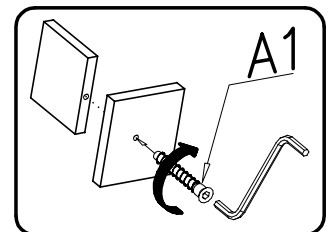
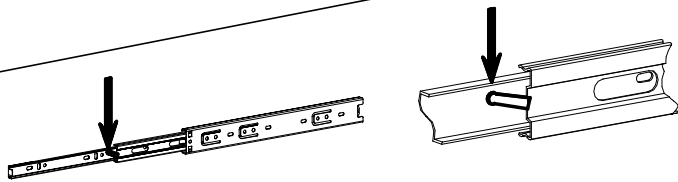

II

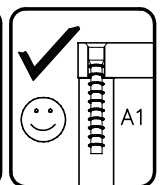
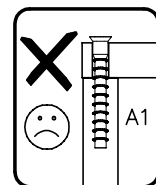
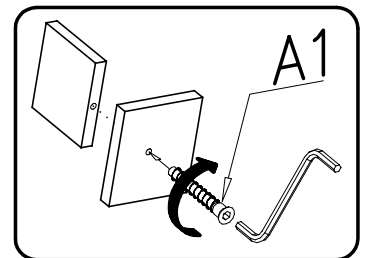
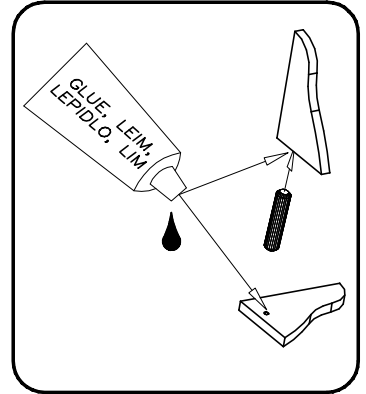
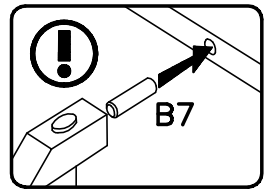
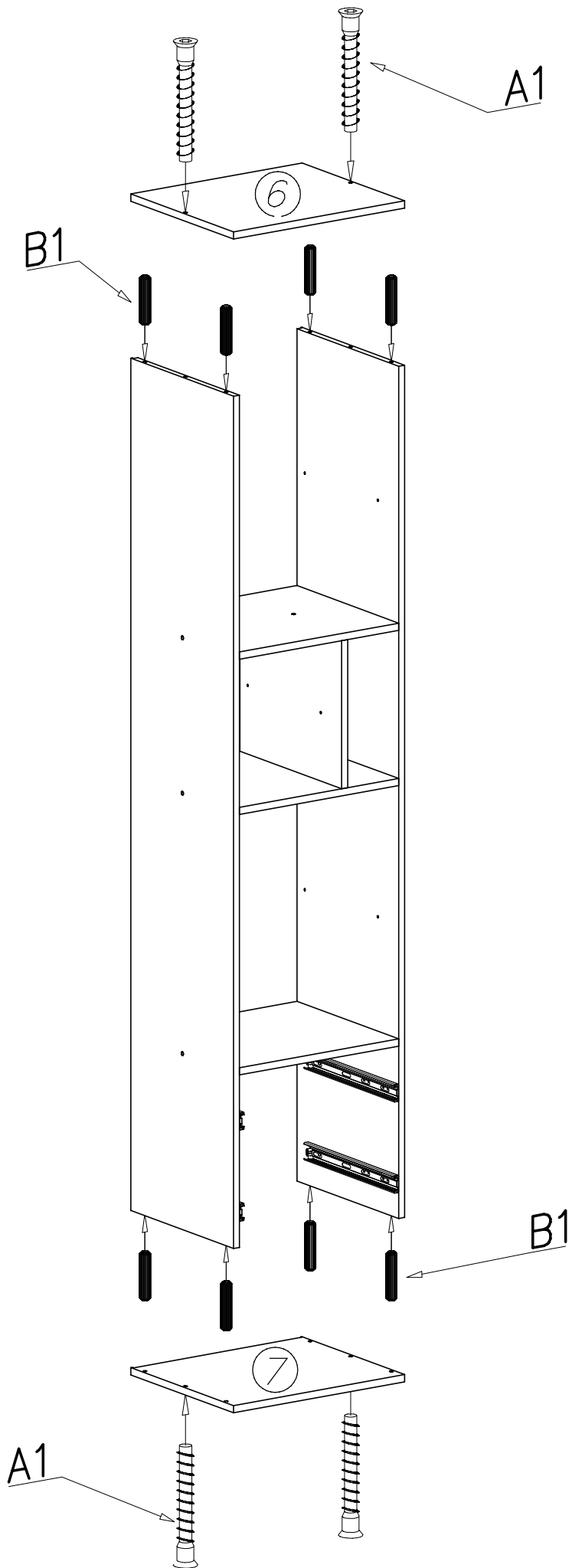

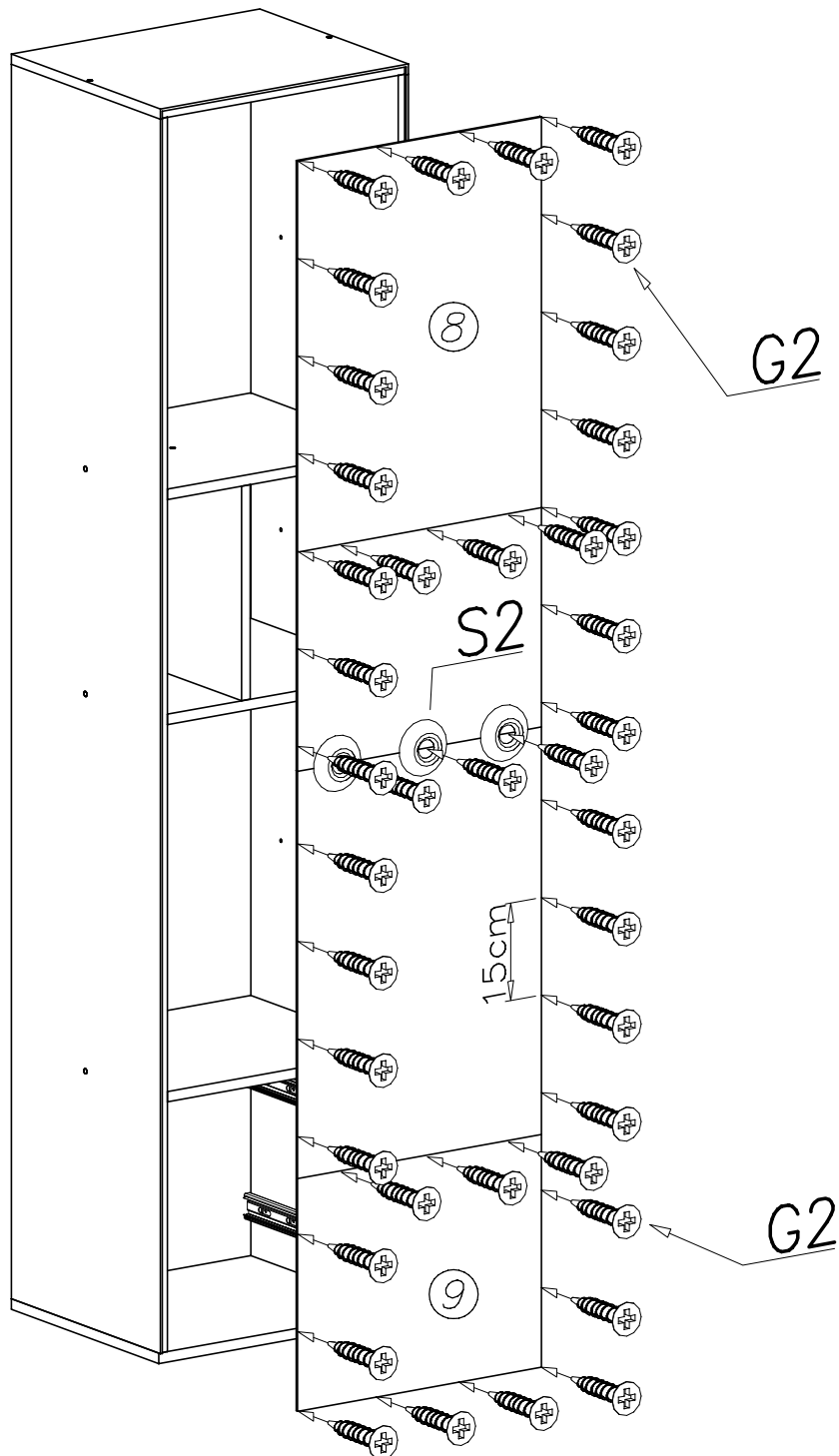
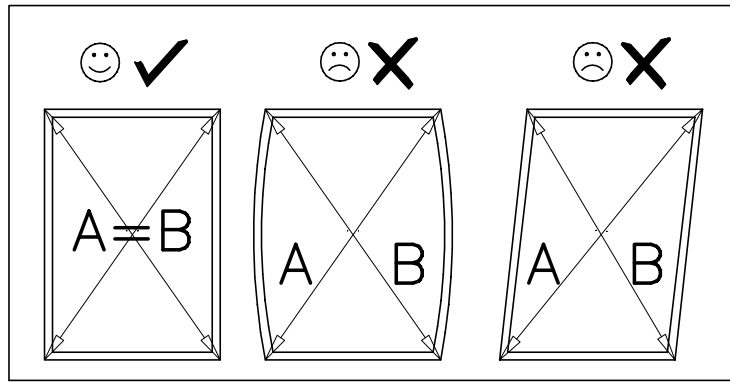

IV

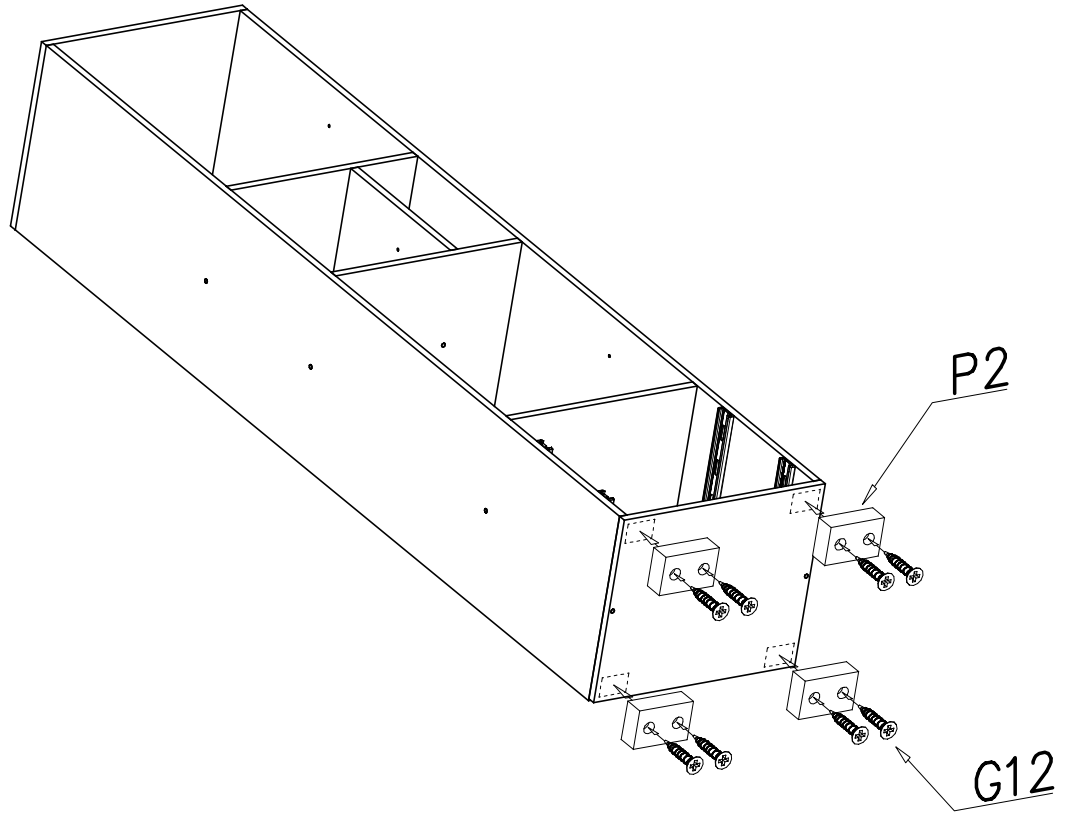

V

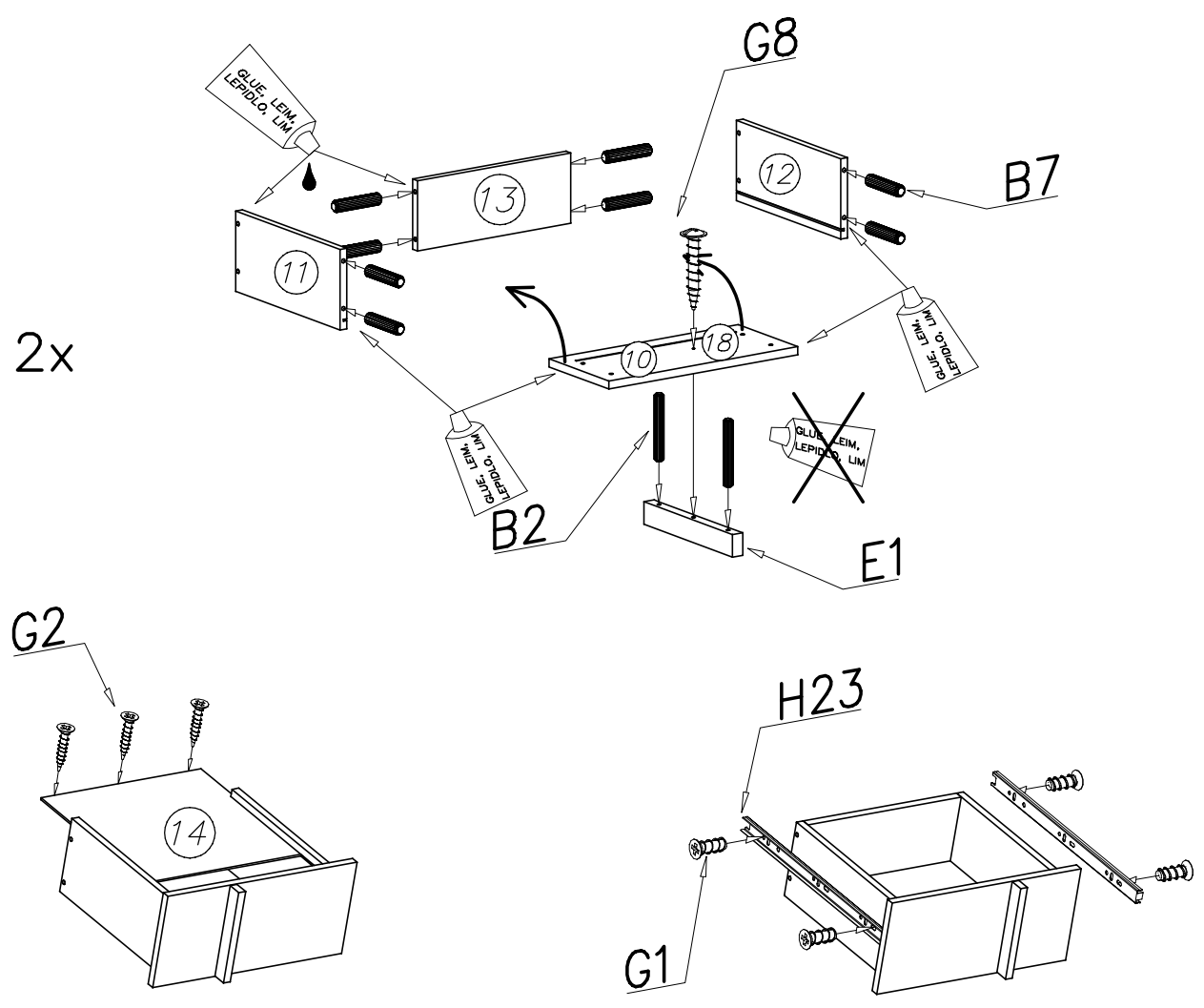

VI

