

(PL) Instrukcja montażu

(CZ) Návod k montáži

(D) Montageanleitung

(GB) Assembly instruction

(F) Model d'emploi

(HU) Szerelési útmutató

(I) Istruzione di montaggio

(NL) Handleiding voor de montage

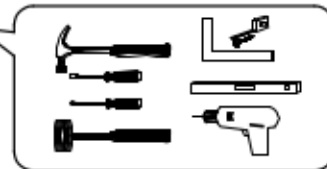
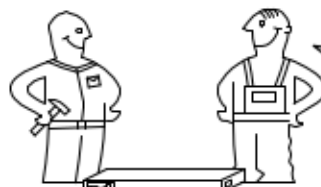

(RU) Инструкция по монтажу

(RO) Instrucțiuni de montare

(SK) Návod k montáži

(TR) Montaj talimatı

**⚠ Uwaga • Upozornění • Achtung • Attention • Caution • Figyelem
Attenzione • Opgelet • Внимание • Atenție • Upozornenie • Dikkat ⚠**

PL Czyszczenie należy wykonać wyłącznie za pomocą ściereczki lub lekko nawilżonego ręcznika. Nie stosować środków czyszczących do szorowania.

CZ Čistění je nutné vykonávat výhradně pomocí utěrky nebo lehkce navlhčeného ručníku. Nepoužívejte čističí prostředky obsahující abrazivní částice.

D Bitte nur mit einem Staubtuch oder leicht feuchtem Lappen reinigen. Keine scheuernden Putzmittel verwenden.

GB Please only clean with a duster or a damp cloth. Do not use any abrasive cleaners.

F Le nettoyage se fait uniquement à l'aide d'un torchon ou d'une serviette légèrement mouillée.

HU A tisztítás kizárólag törölruha vagy enyhén nedvesített törölköző segítségével végezhető. Súroló hatású tisztítószereket nem szabad használni.

I Pulire esclusivamente con un panno o un asciugamano umido.

NL Reinig alleen met een stofdoek of een lichtjes vochtige doek. Gebruik geen schurende poetsmiddelen.

RU Очищайте от пыли тряпкой или слегка влажной ветошью. Не допускается применение чистящих средств, не предназначенных для ухода за мебелью.







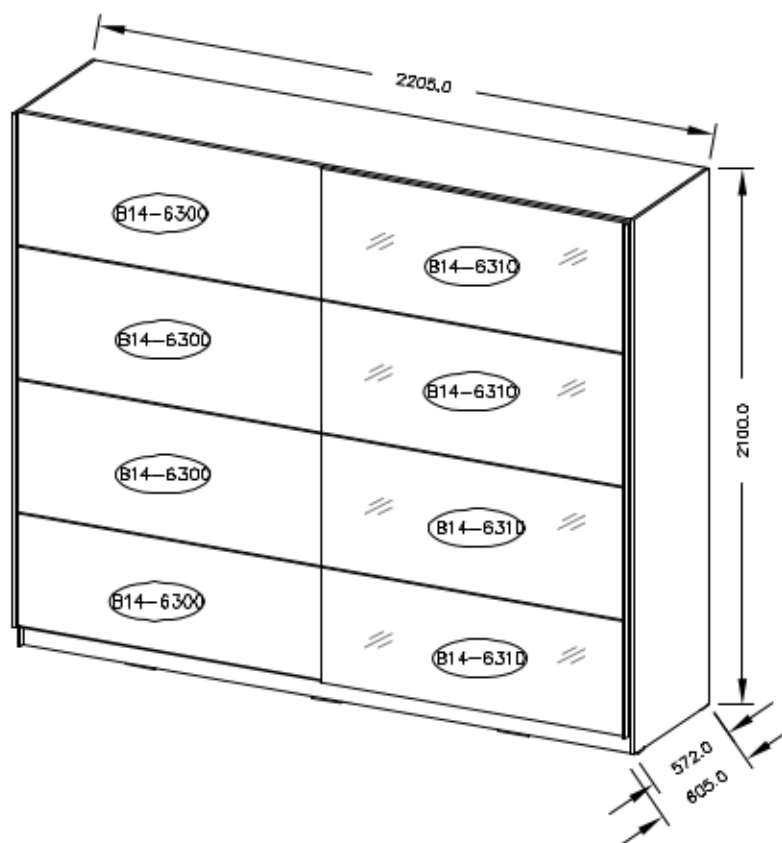
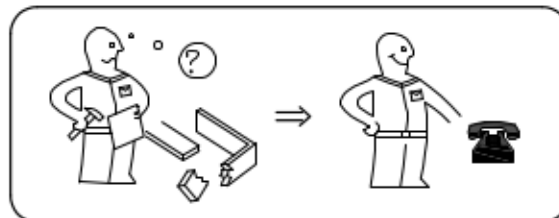
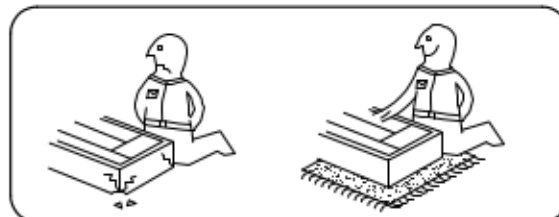

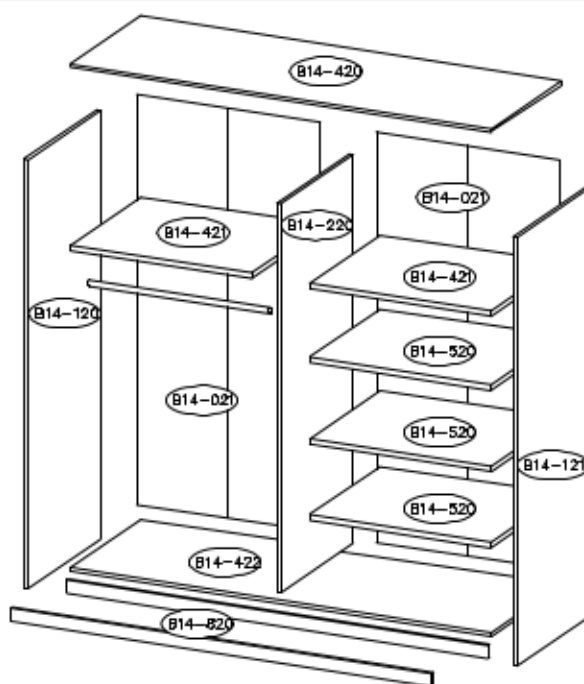
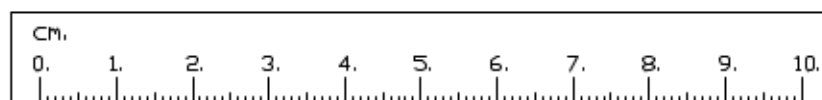
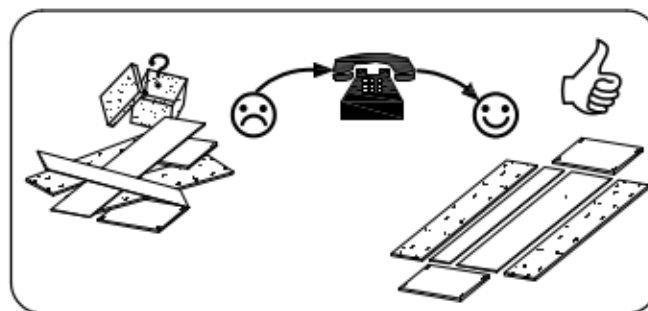
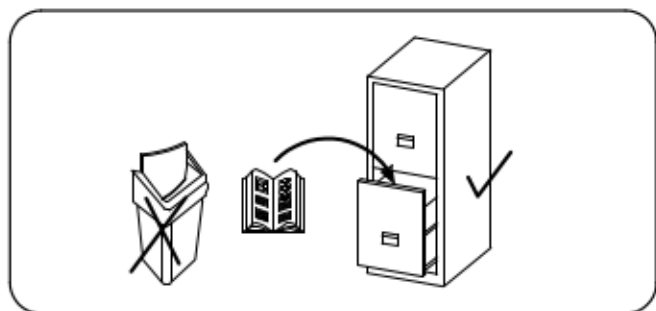











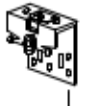











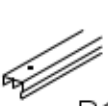



RO Curățarea trebuie efectuată numai cu o cârpă sau cu un prosop ușor umezit. Nu utilizați agenți de curățare abrazivi.

SK Čistení je nutné vykonávať výhradne pomocí utierky alebo ľahko zvlhnutým ručníkom. Nepoužívajte čistiaci prostriedky obsahujúci abrazívni častice.

TR Lütfen sadece bir toz bezile veya hafif nemli yumuşak bir bezle siliniz. Aşındırıcı temizlik malzemeleri kullanmayınız.



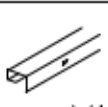
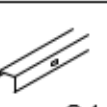

 A	 B	 C	 D	 F	 G	 H	 I	 J	 K	 L
16	48	20	24	24	12	12	1	12	4	2
 M	 N	 O	 P	 R	 S	 T	 U	 W	 Z	 V
1	6	12	2	2	1	2	8	2	2	10
 A1	 B1	 PCV C1	 D1	 E1	 G1	 H1	 I1	 J1	 K1	 L1
1	1	1	5	2	6	24	2	2	18	2
 P1	 Z1	 V1	 Q1	 J2	 D5					
32	1	2	2	12	2					

8.0x30 D	I	V	G1	3.5x13 H1
8	1	6	6	24

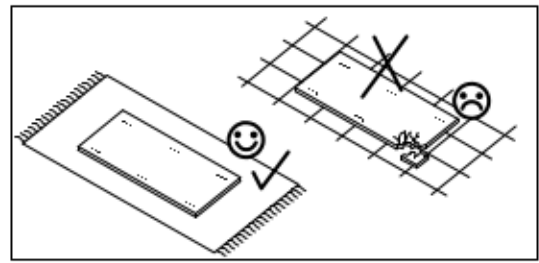



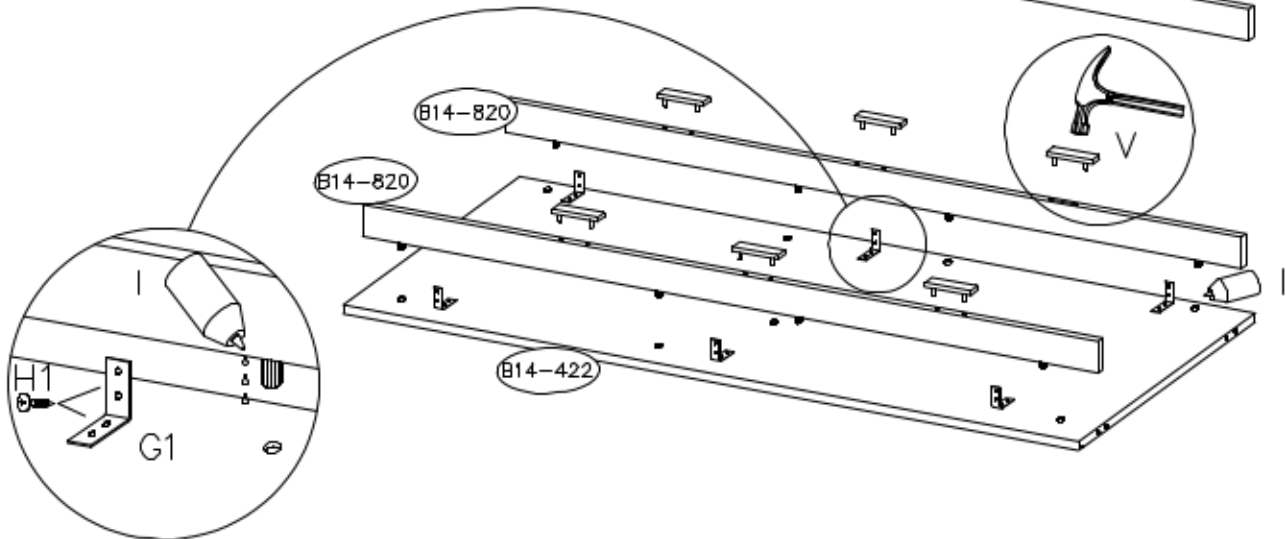
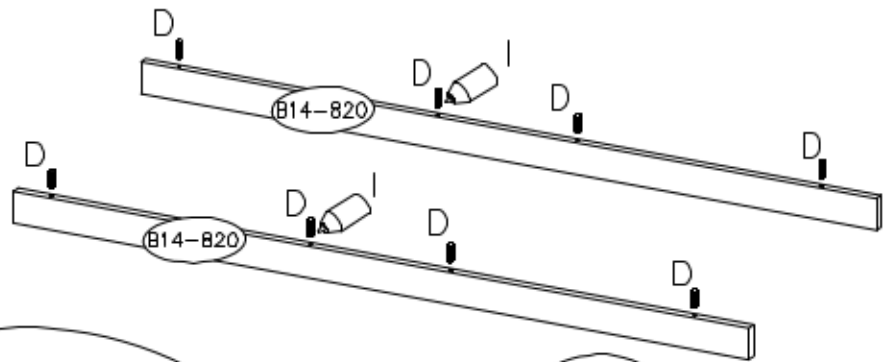

1



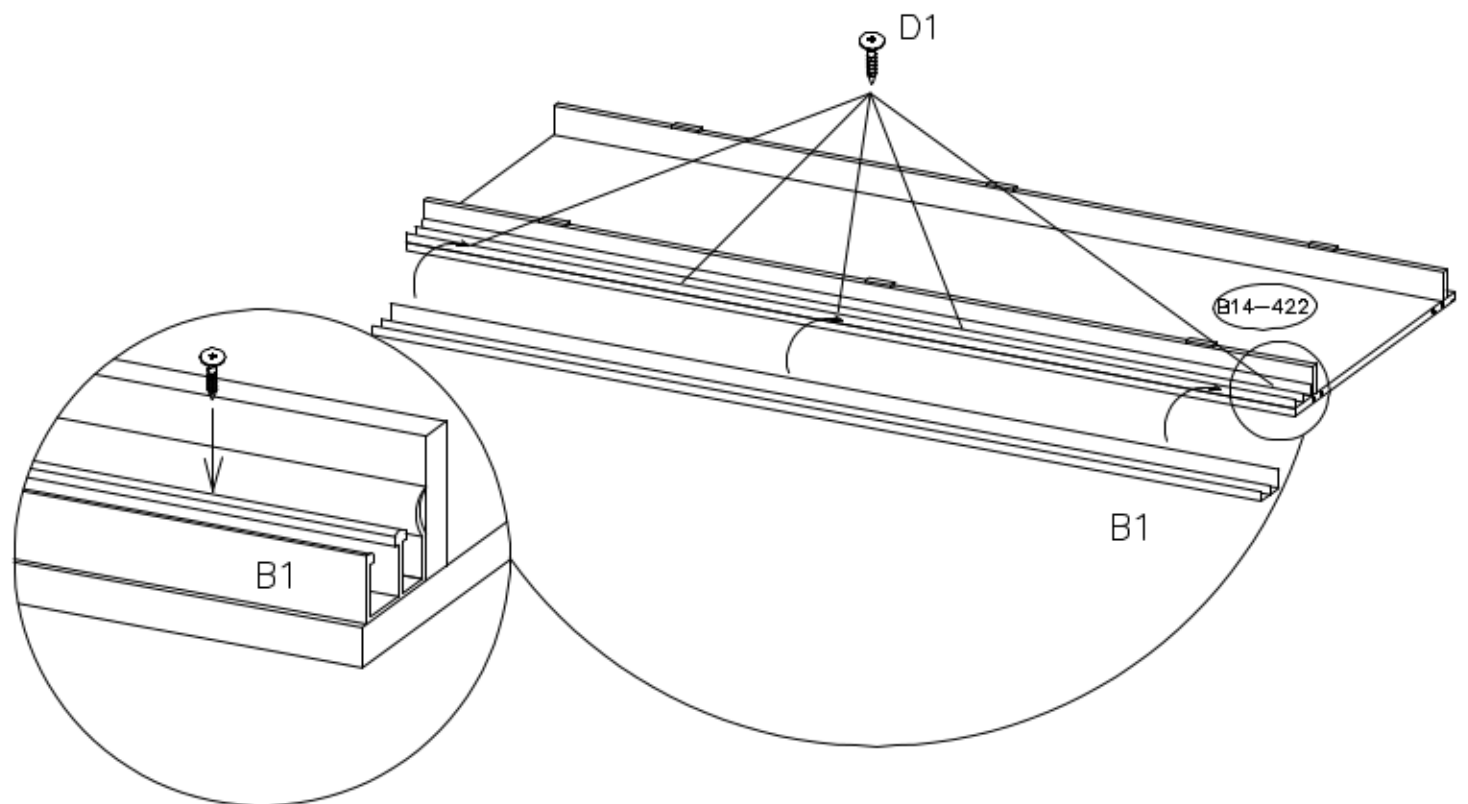



B1	3.5x16 D1
1	5

2

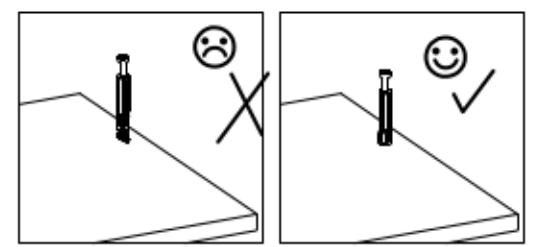
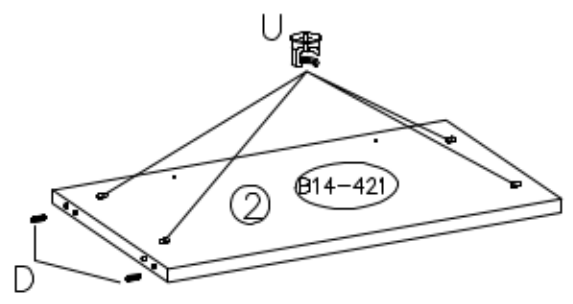
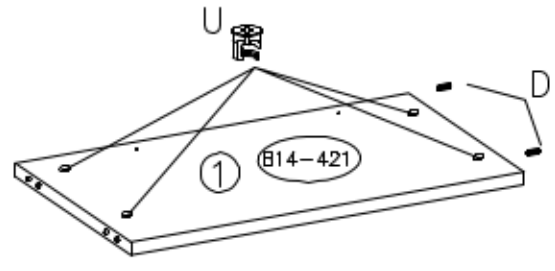
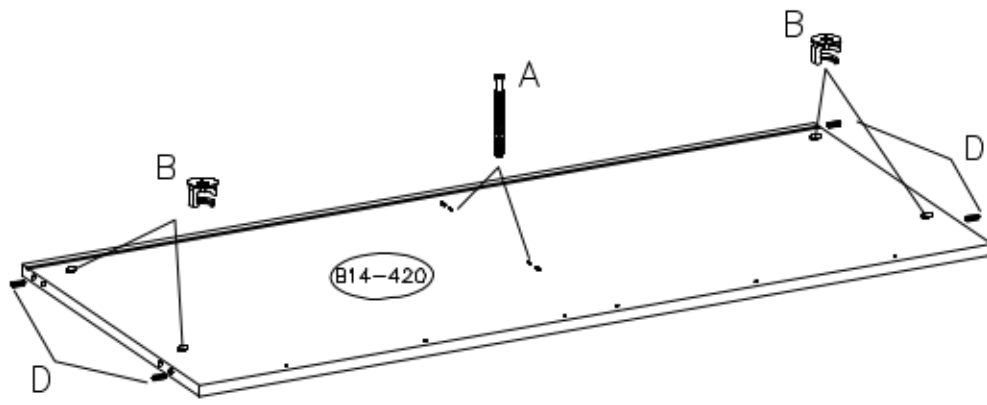
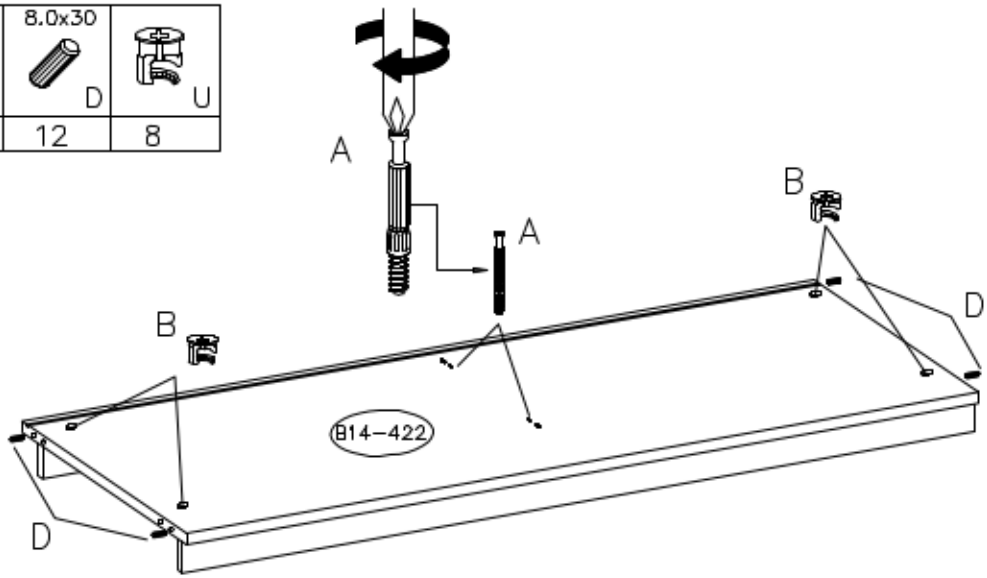



			
A	B	8.0x30 D	U
4	8	12	8

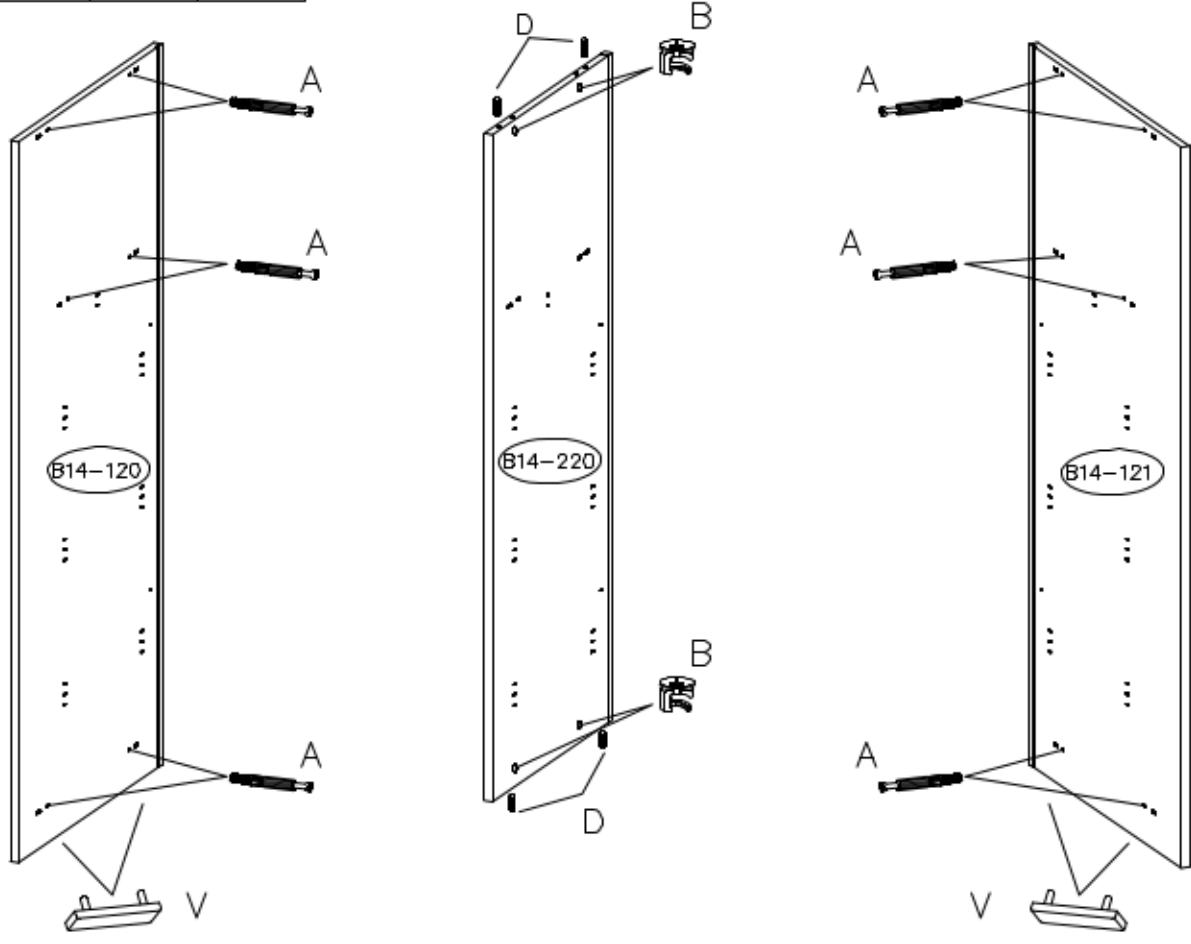

			
A	B	8.0x30	D
12	4	4	4



	
G	6.3x11
2	2

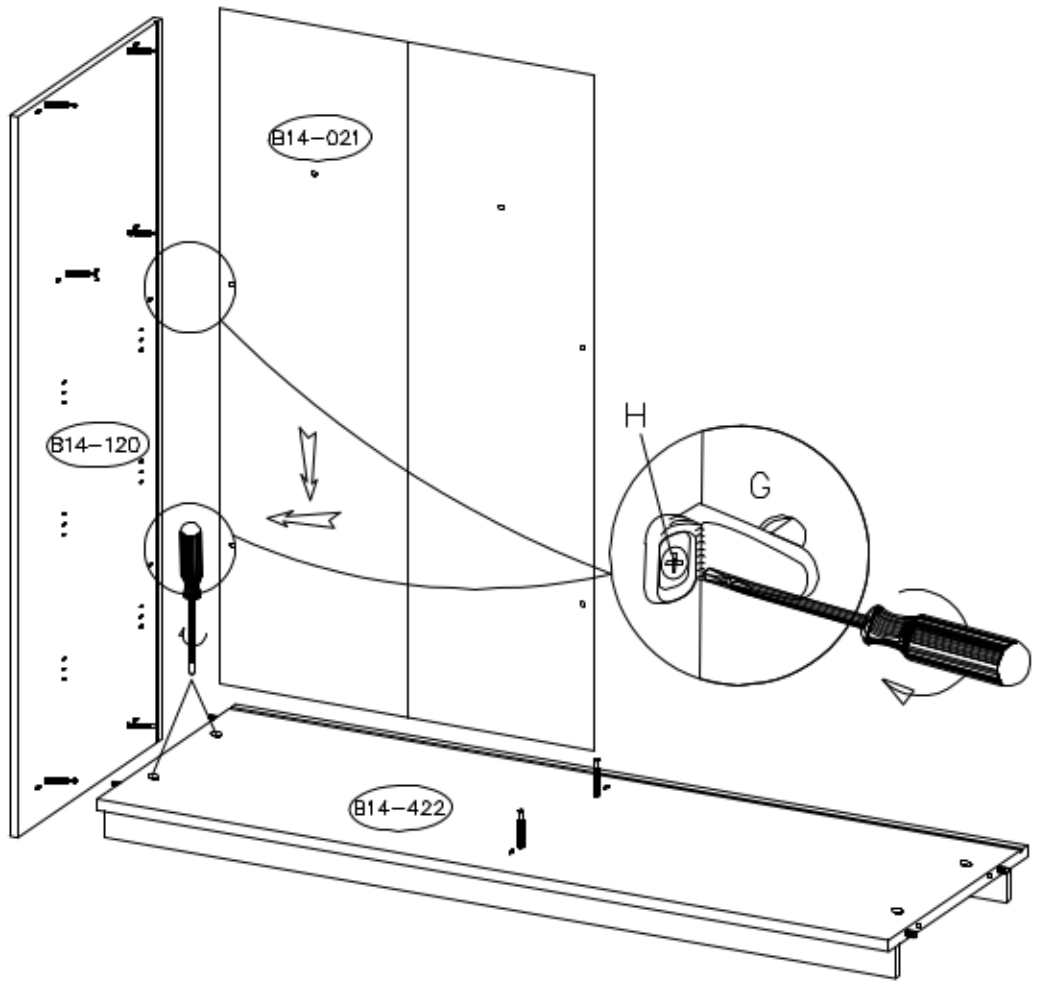

6

	6.3x11
G	H
2	2

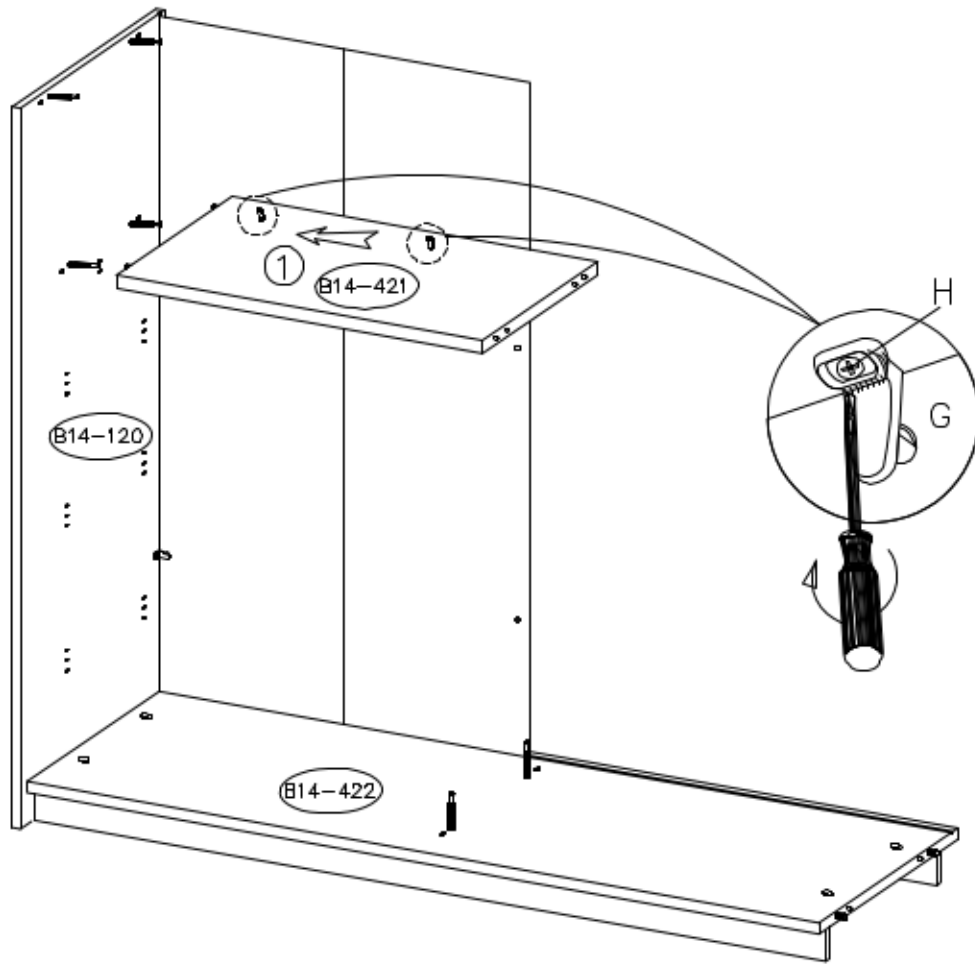

7

	6.3x11
G	H
2	2

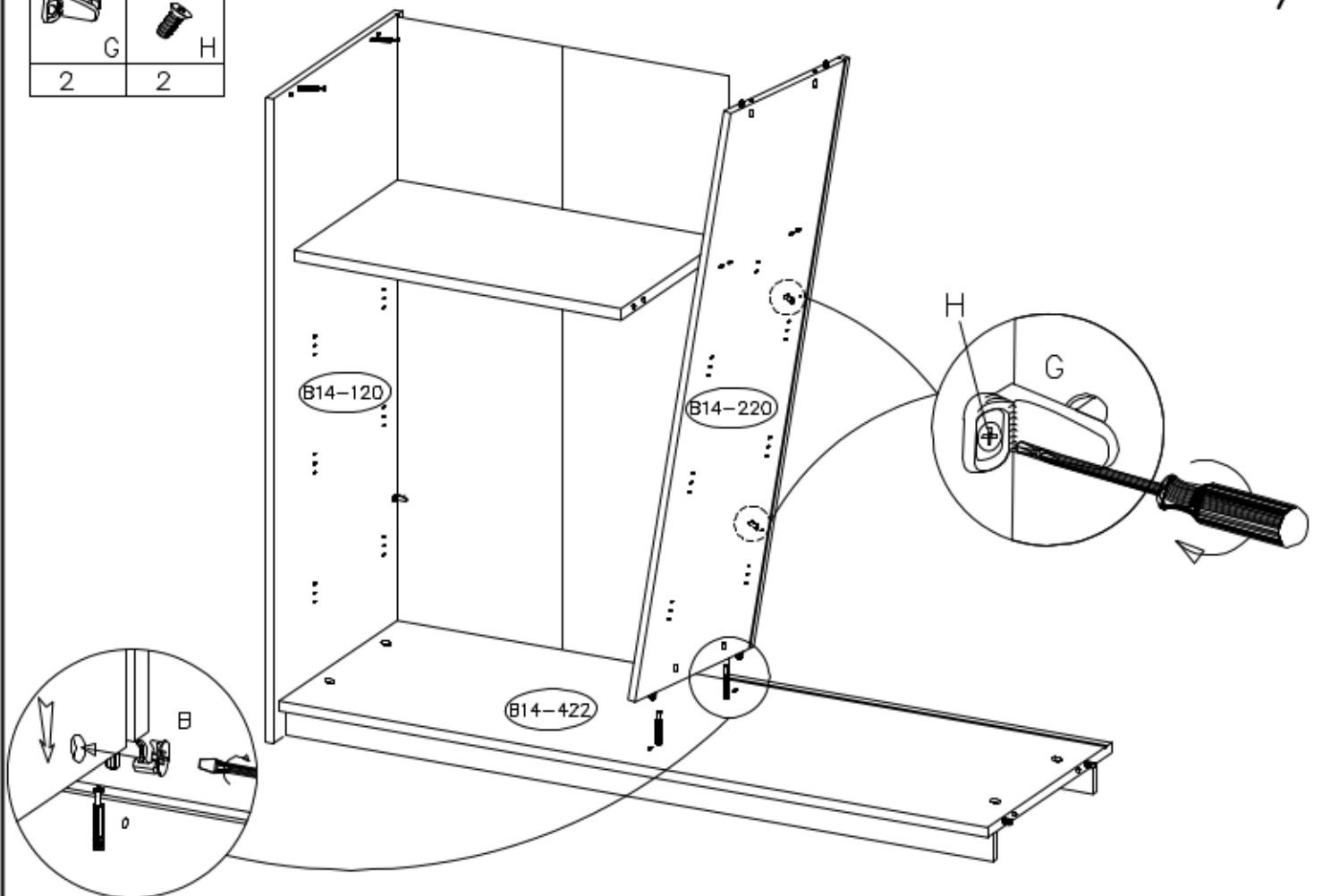

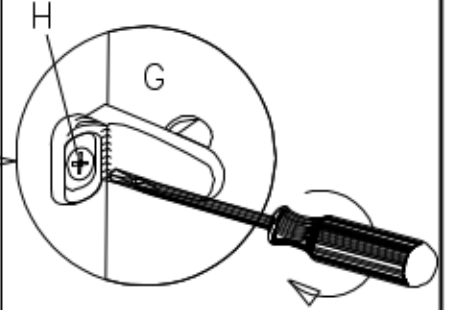
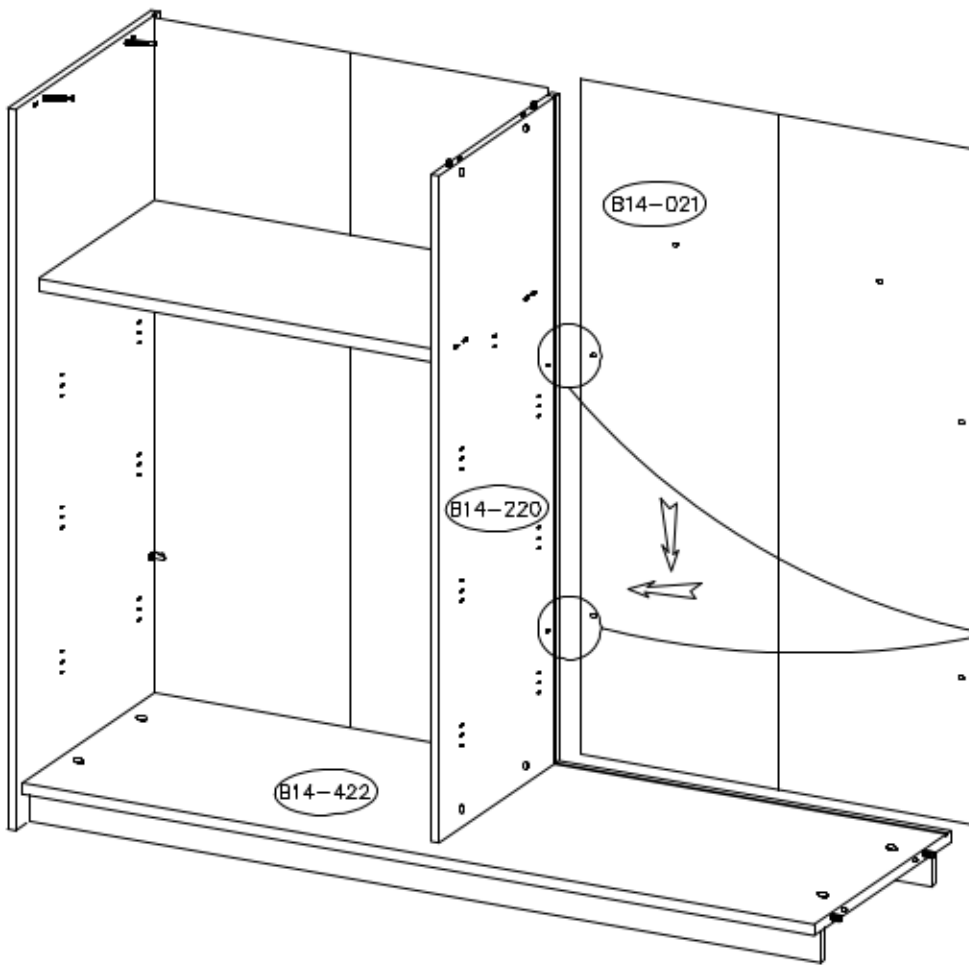

	6.3x11
G	H
2	2

8



	6.3x11
G	H
2	2

9

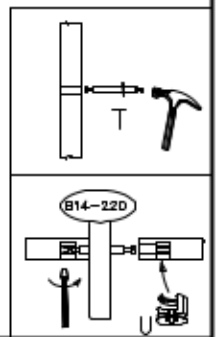
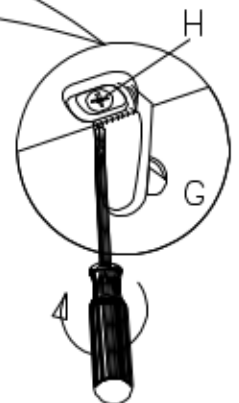
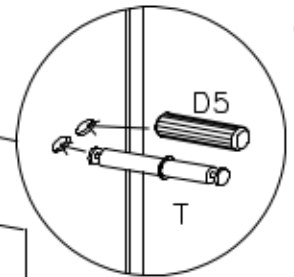
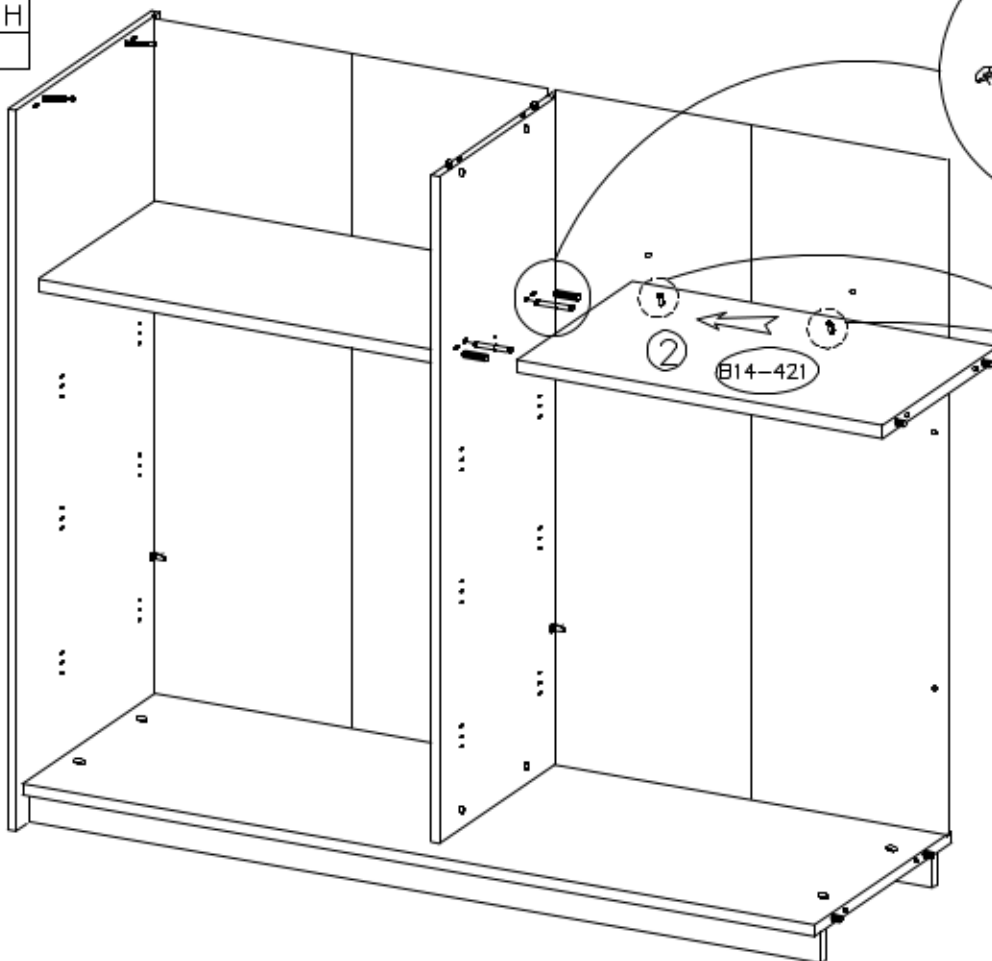

T
2

B.0x50

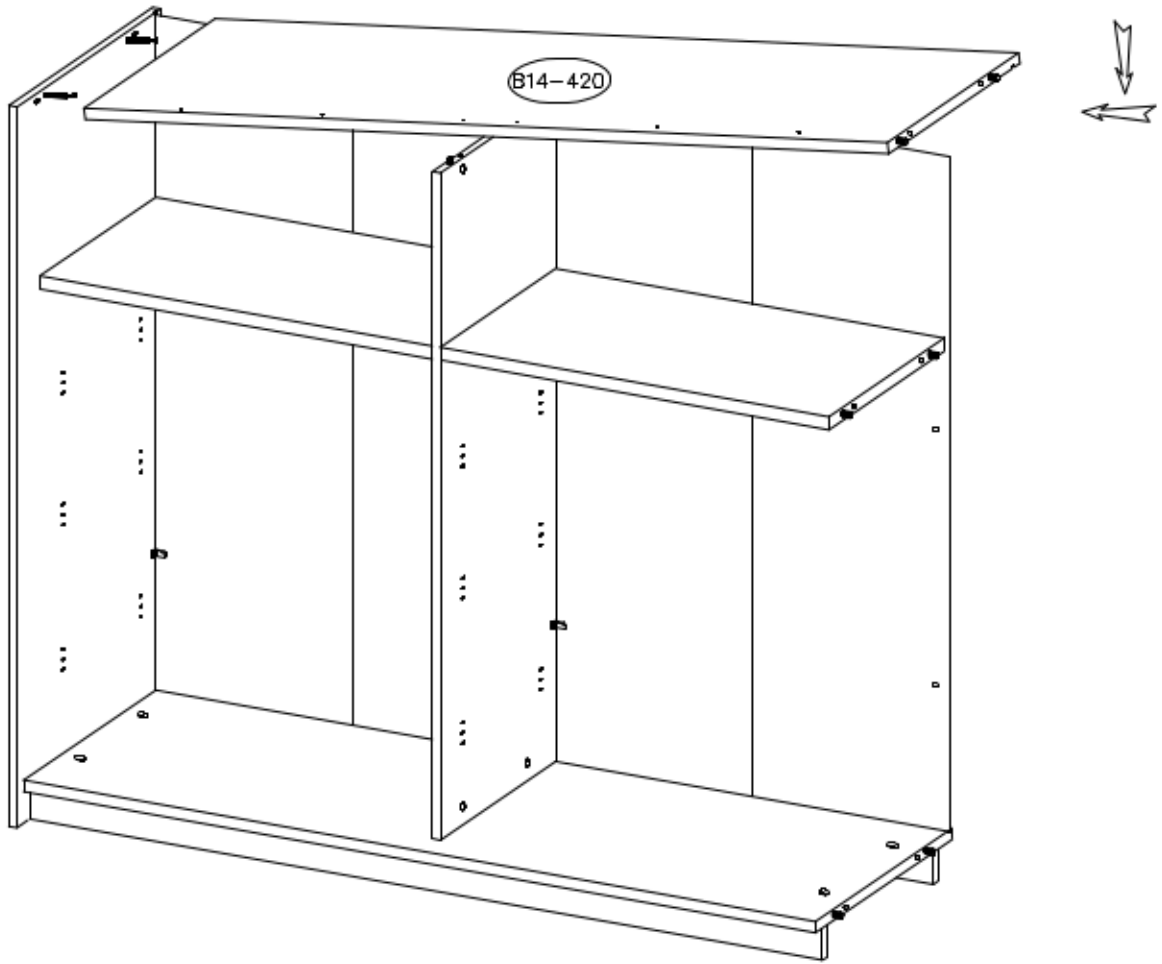
D5
2



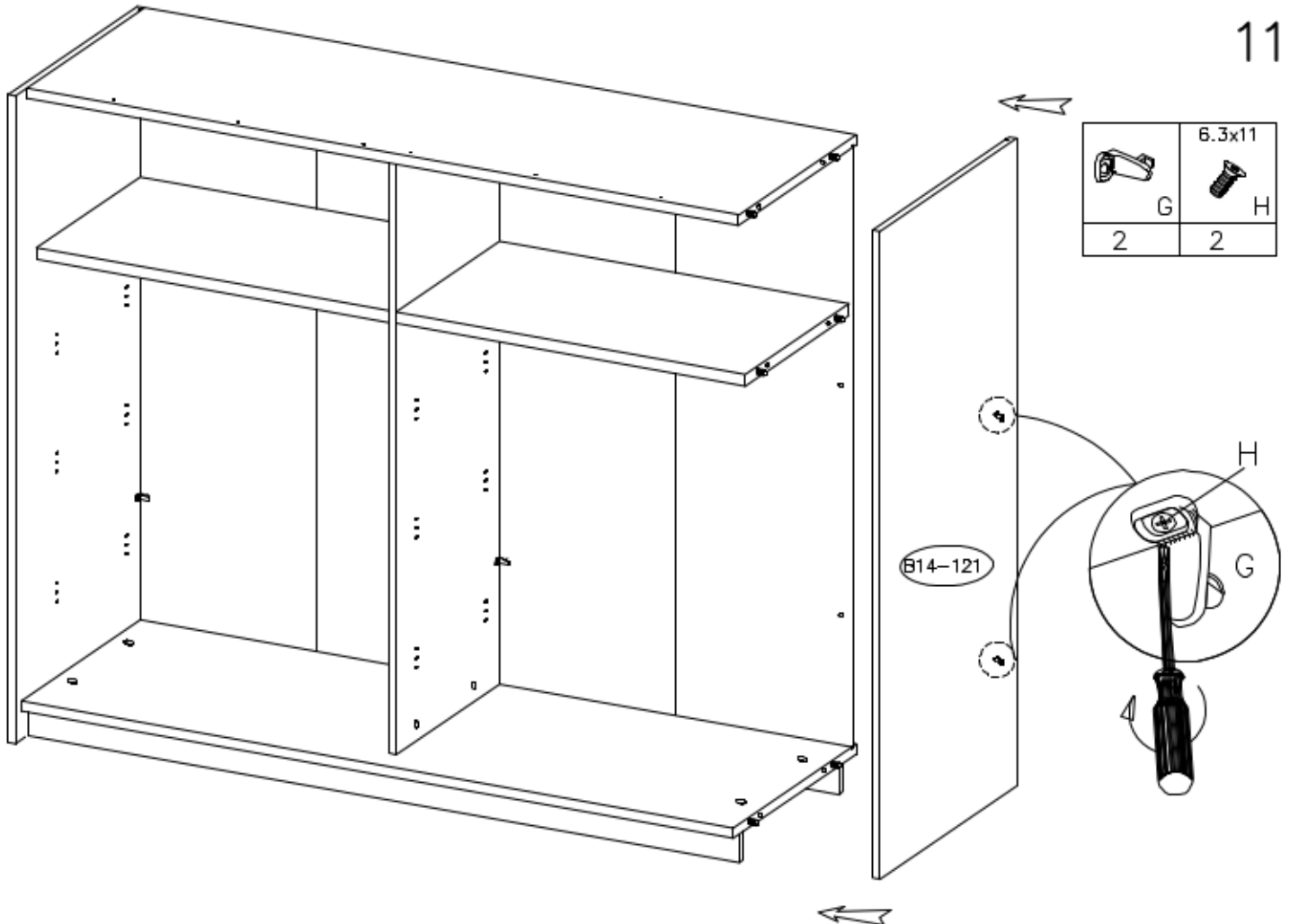

10





11



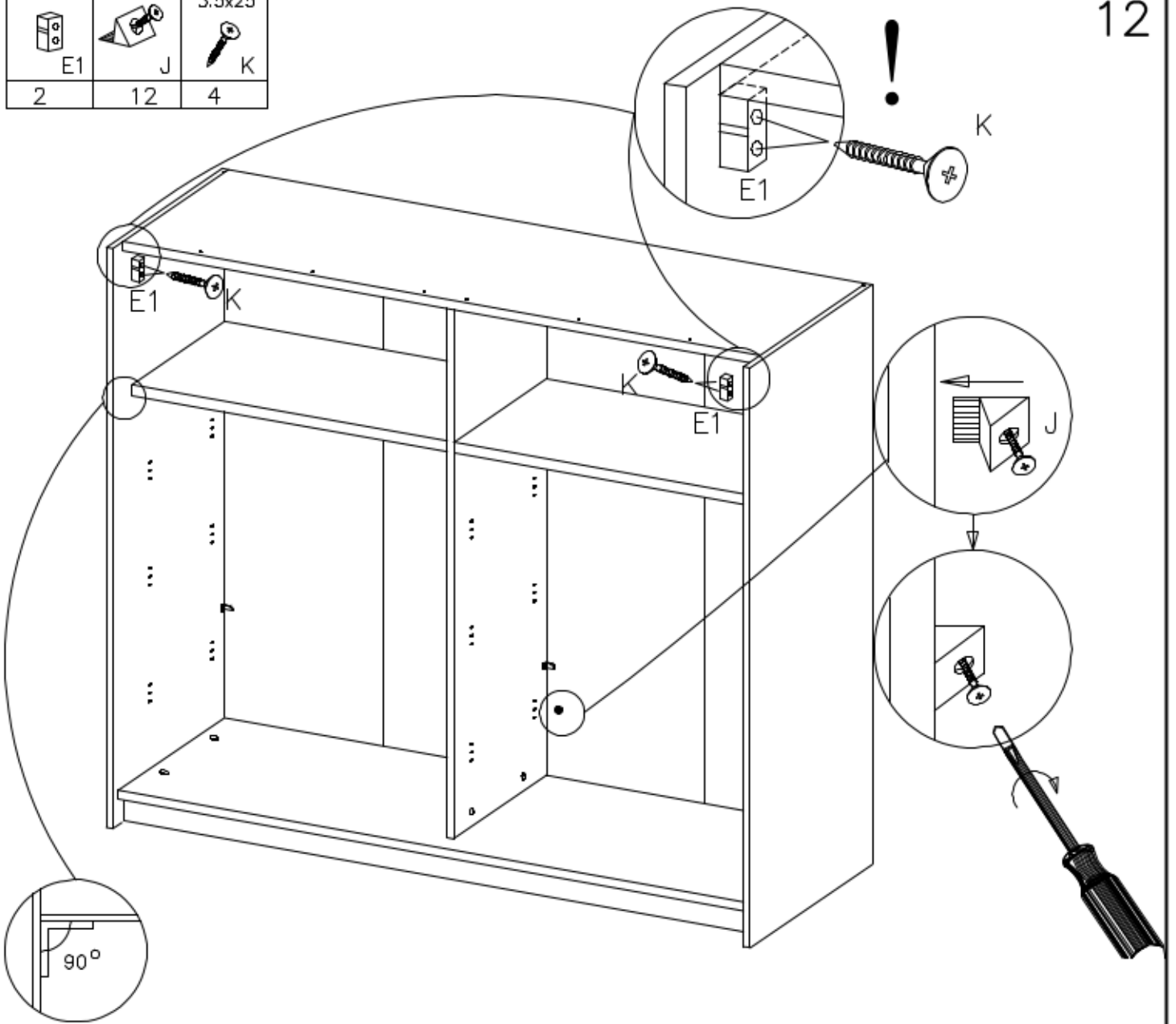

 E1	 J	3.5x25  K
2	12	4



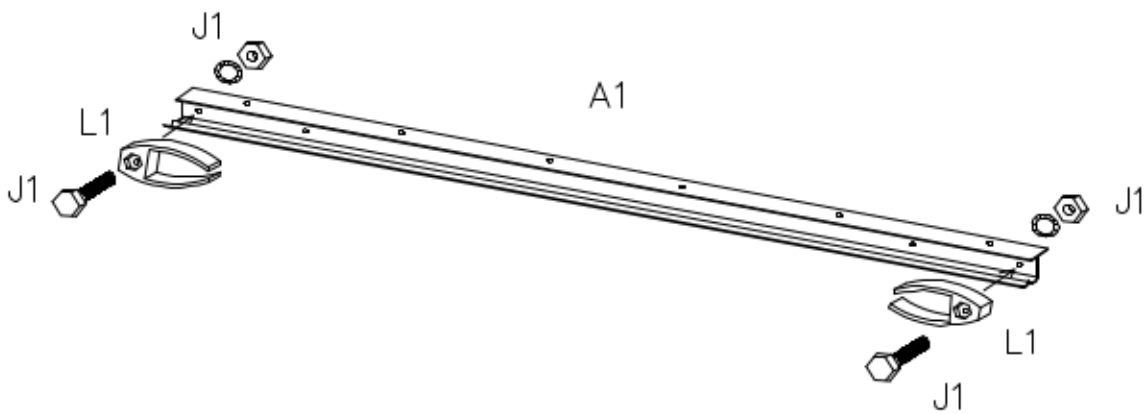



 A1	 J1	 L1
1	2	2

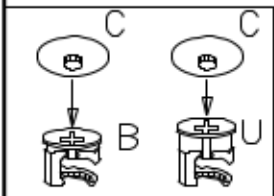
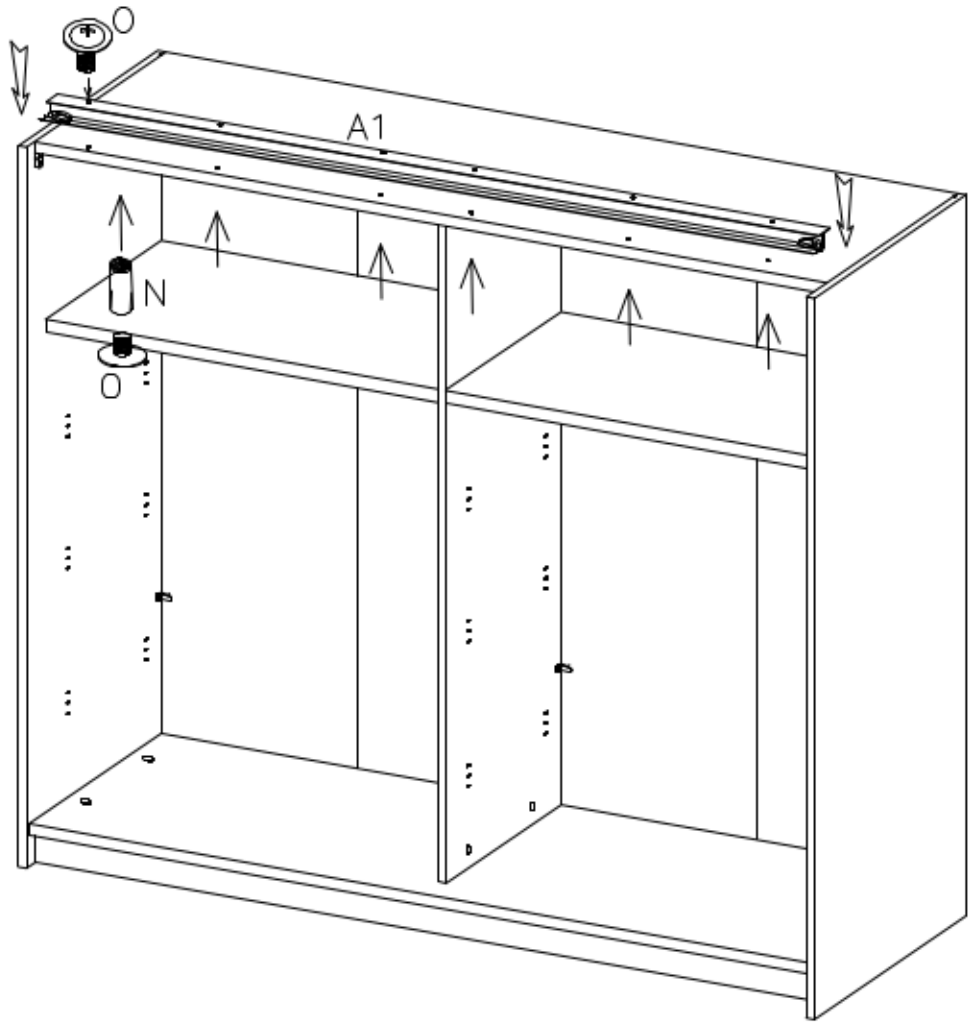

	
N	O
6	12
	
C	
20	



		
P	3.0x13 R	Z1
2	2	1
		
J2		
12		

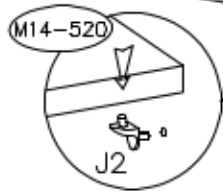
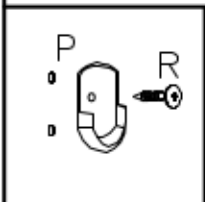
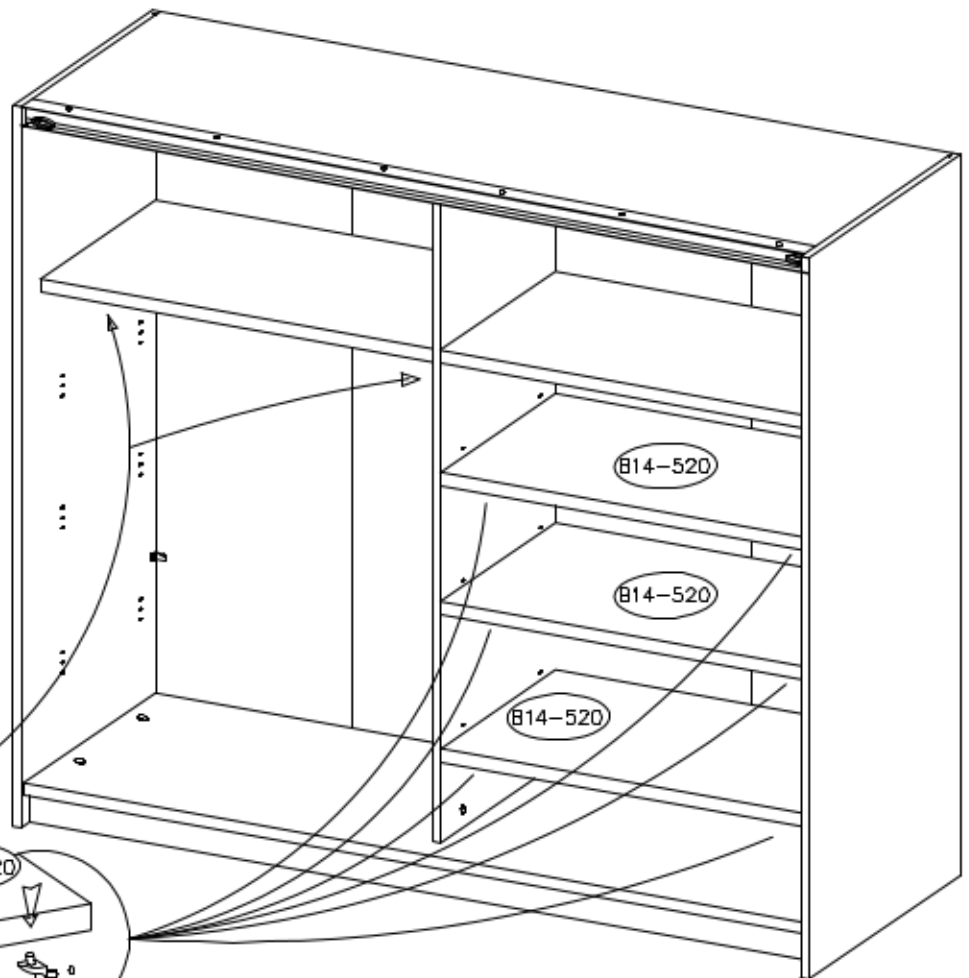
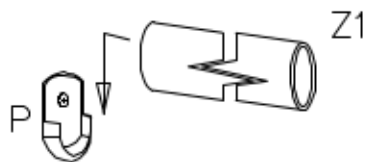

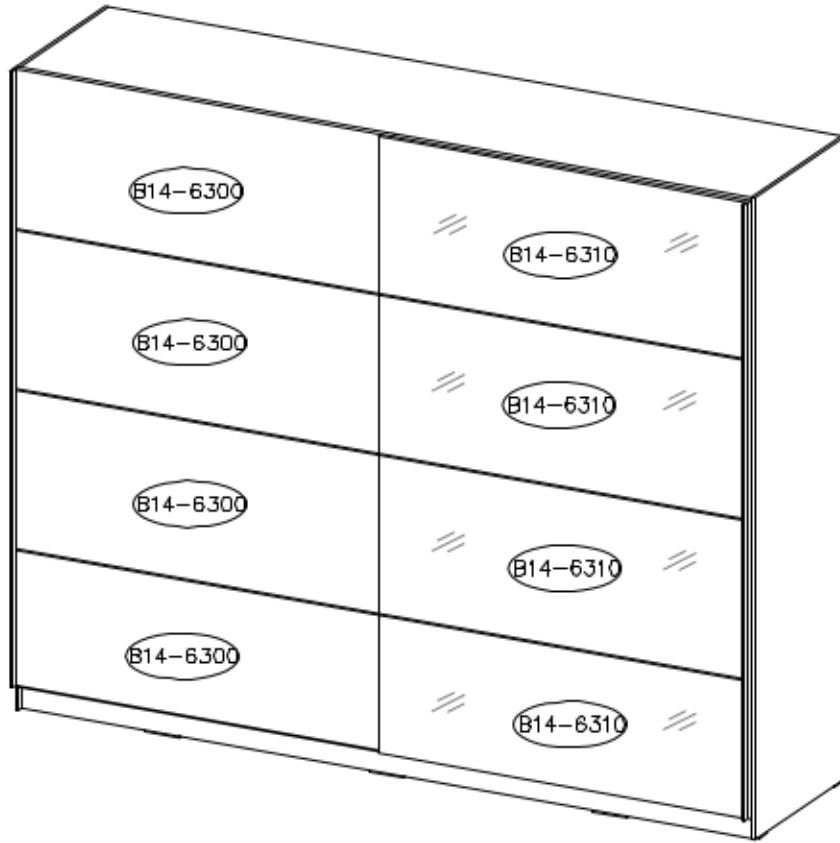

a



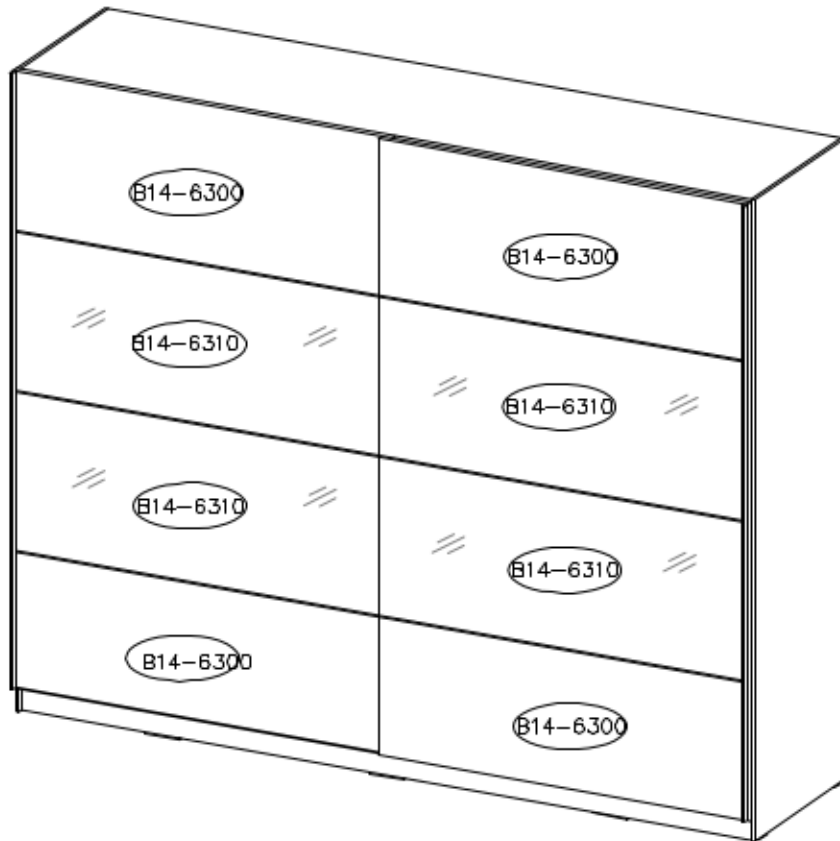

b



	
B	K1
18	9

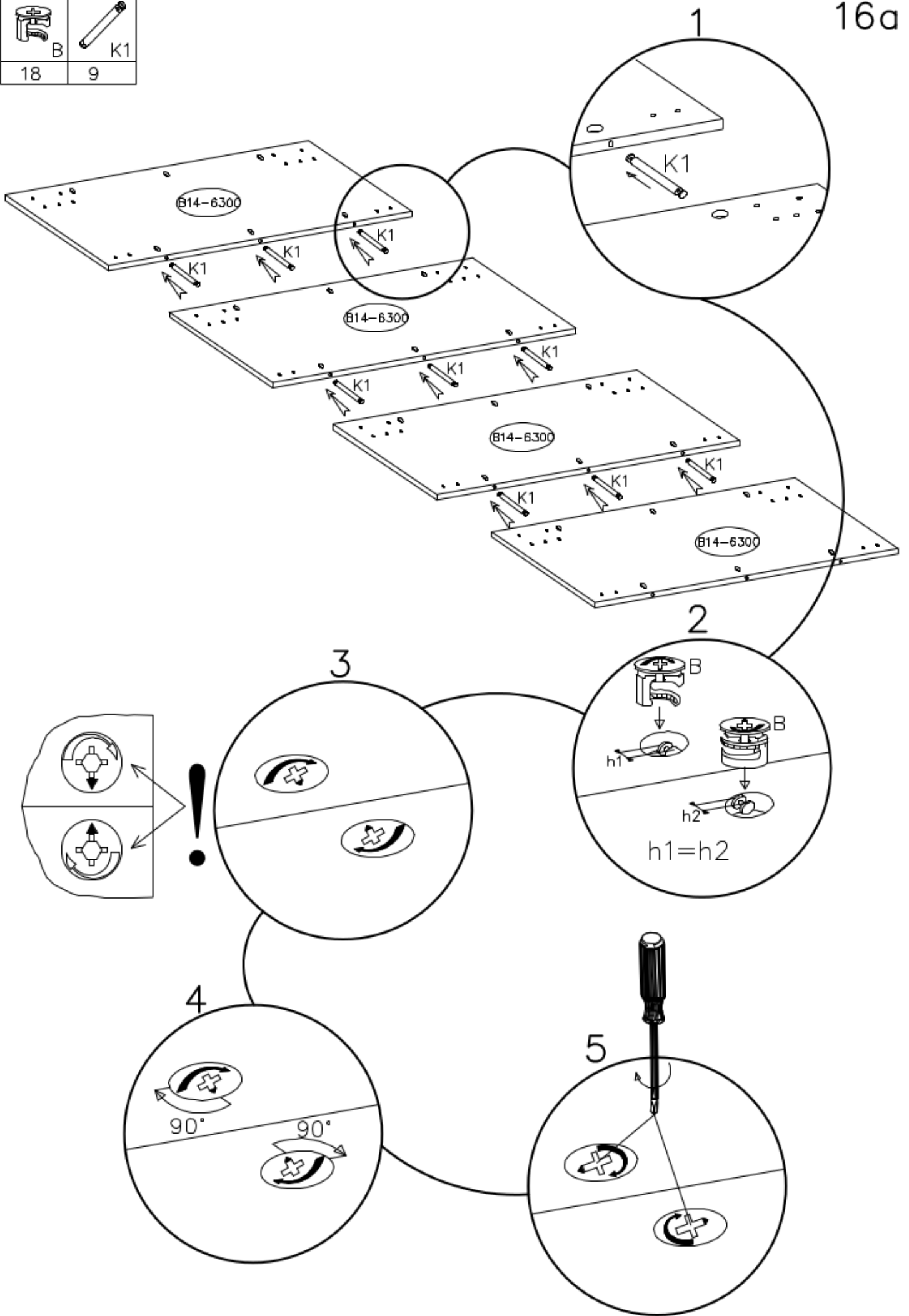

16a



	
B	K1
18	9

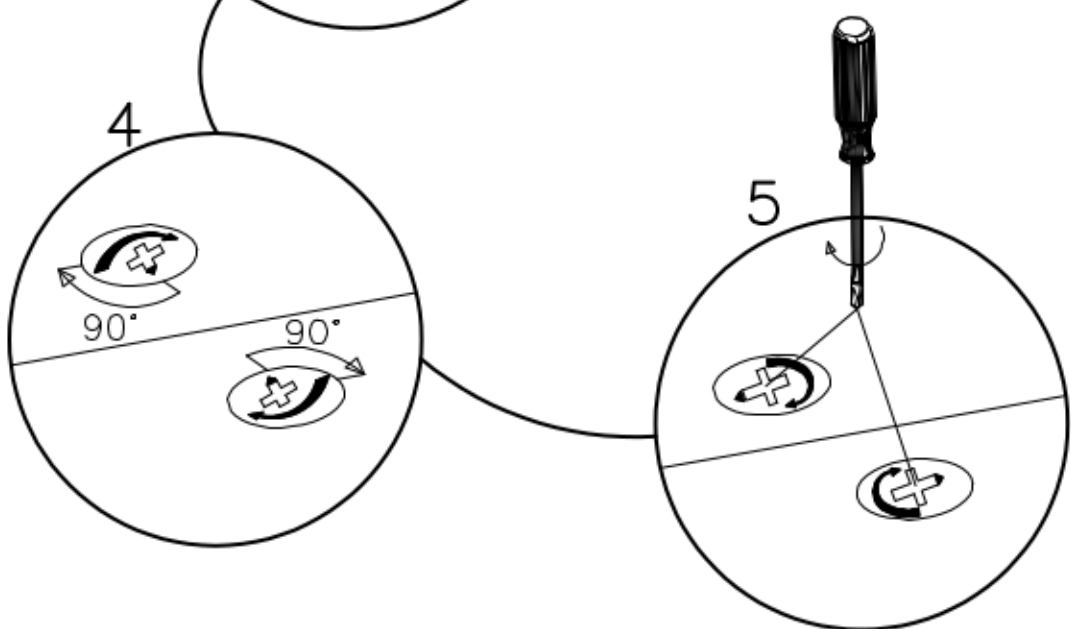
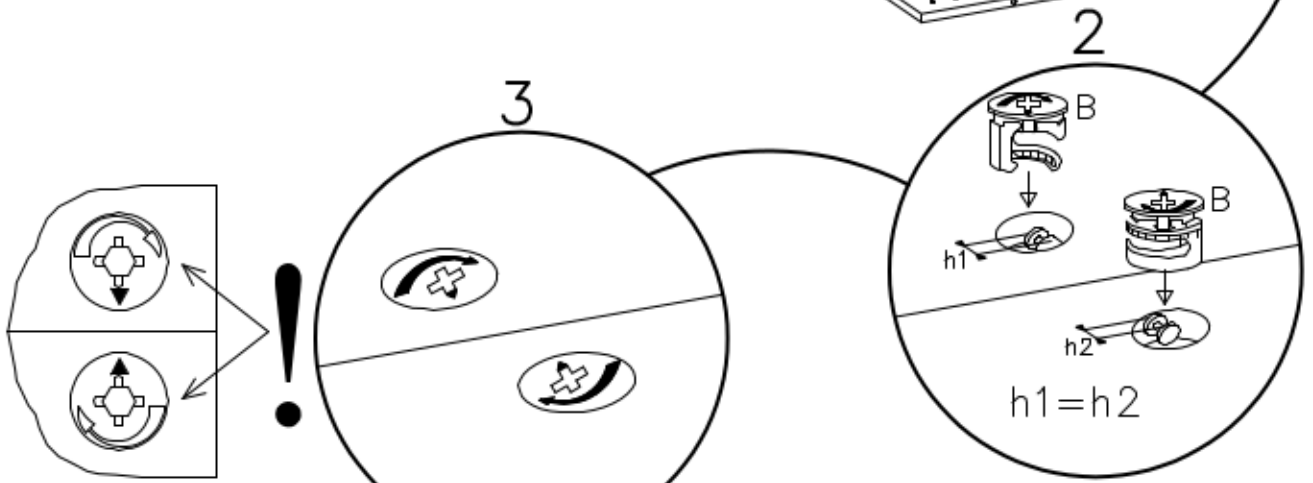
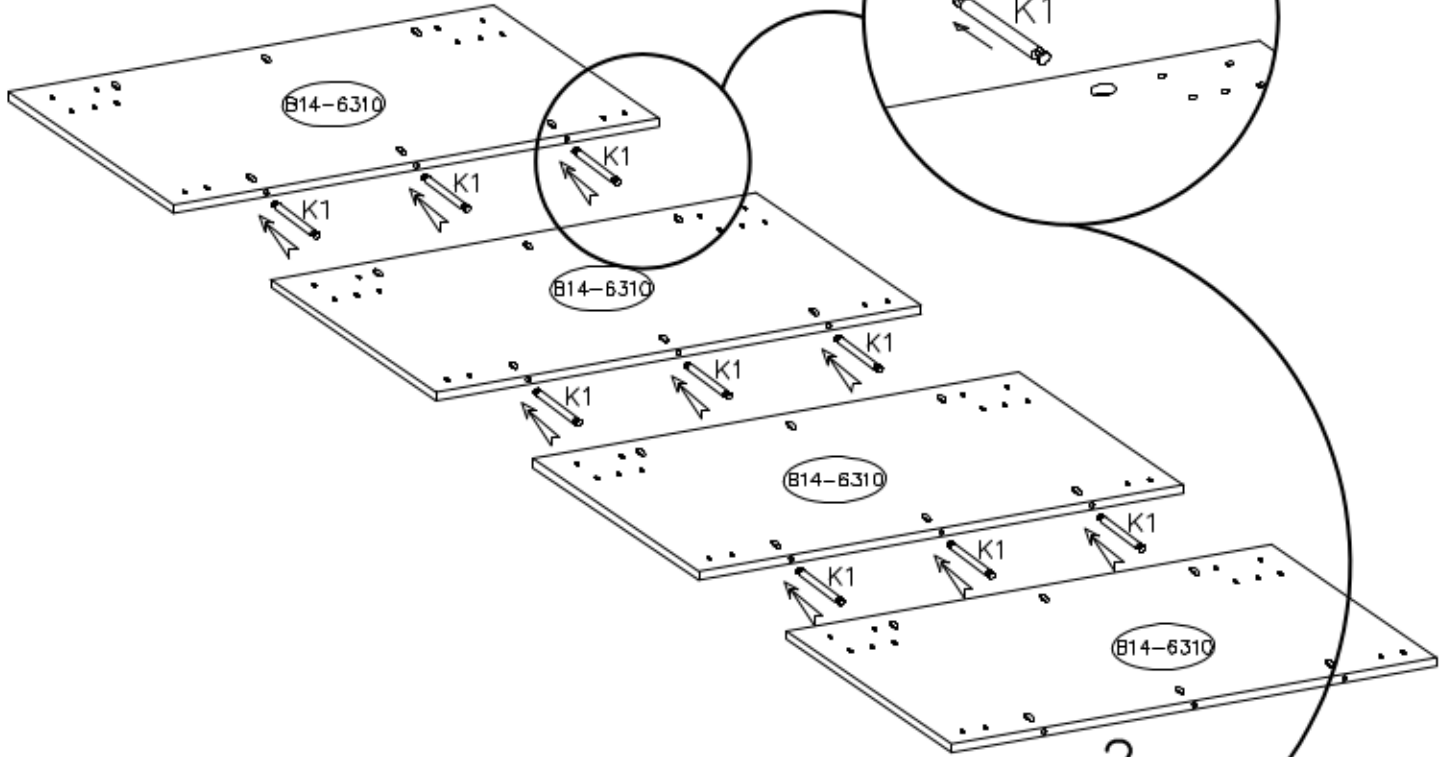

17a



3.5x13		
 P1	V1	Q1
16	1	1

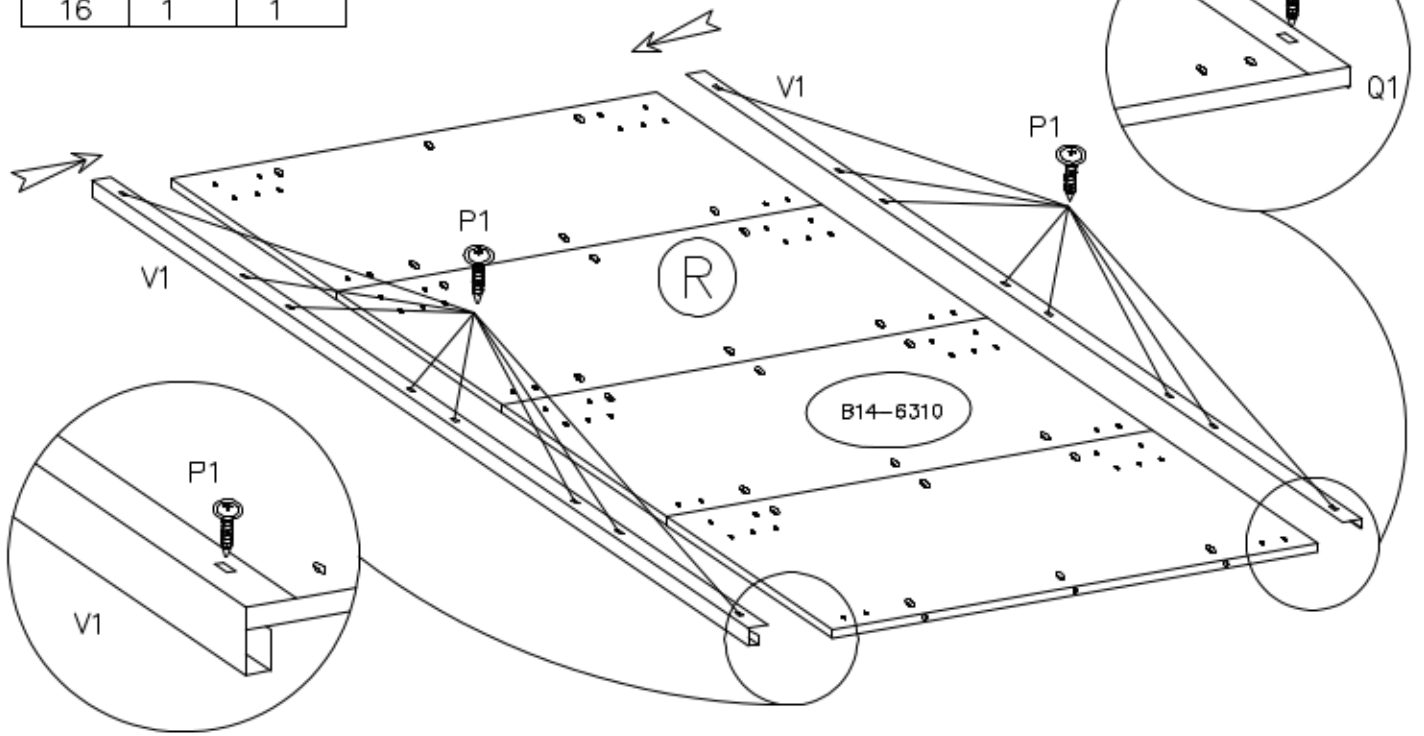

18a



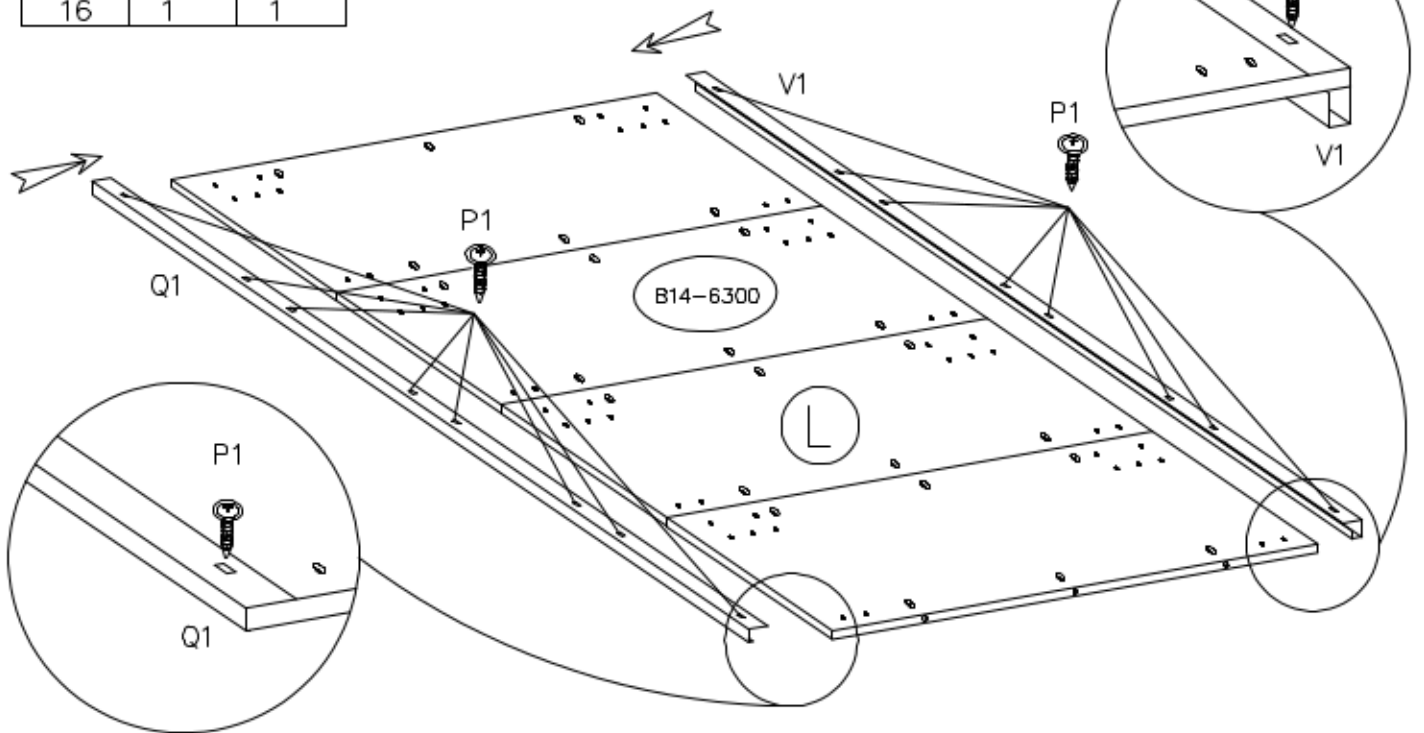

3.5x13		
 P1	V1	Q1
16	1	1

19a

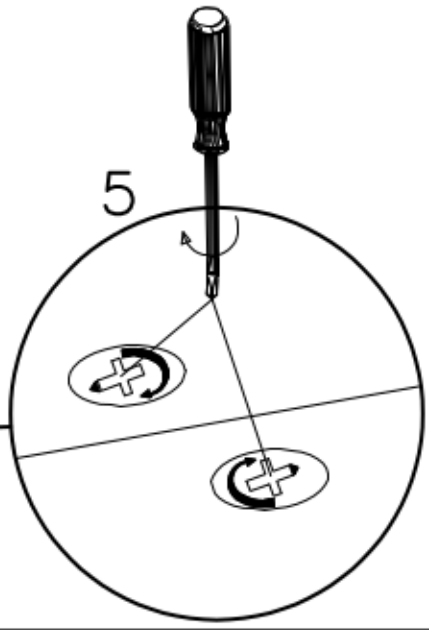
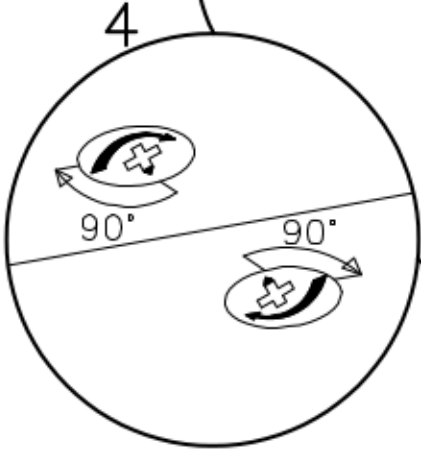
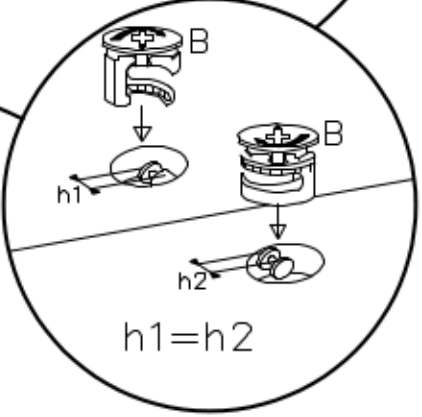
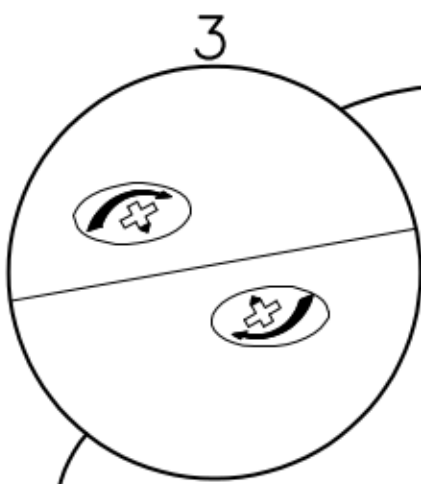
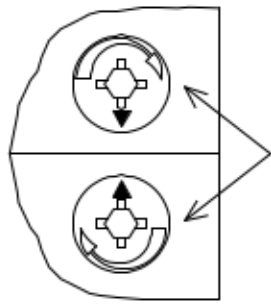
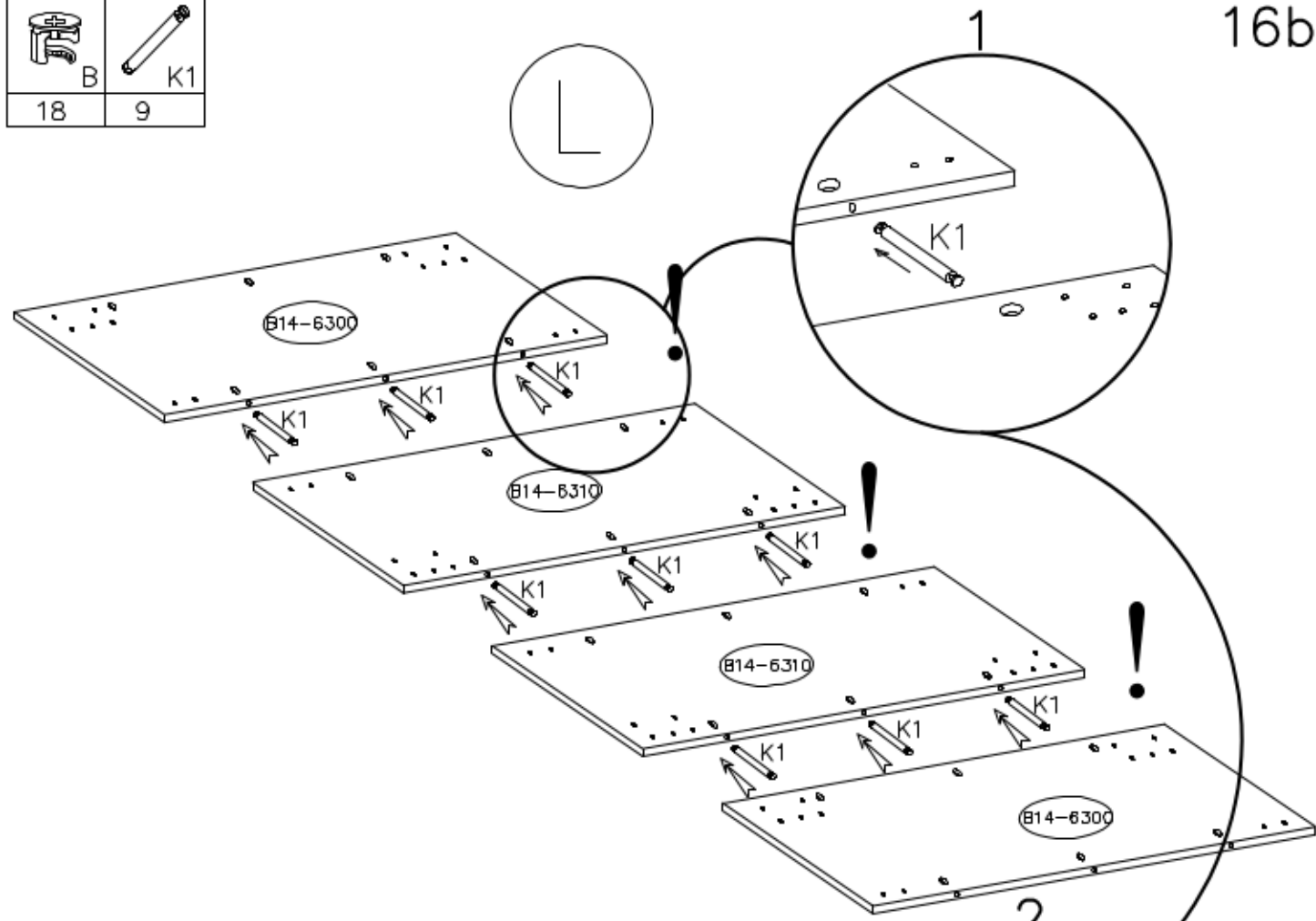

 B 18	 K1 9
--	---



	
B	K1
18	9

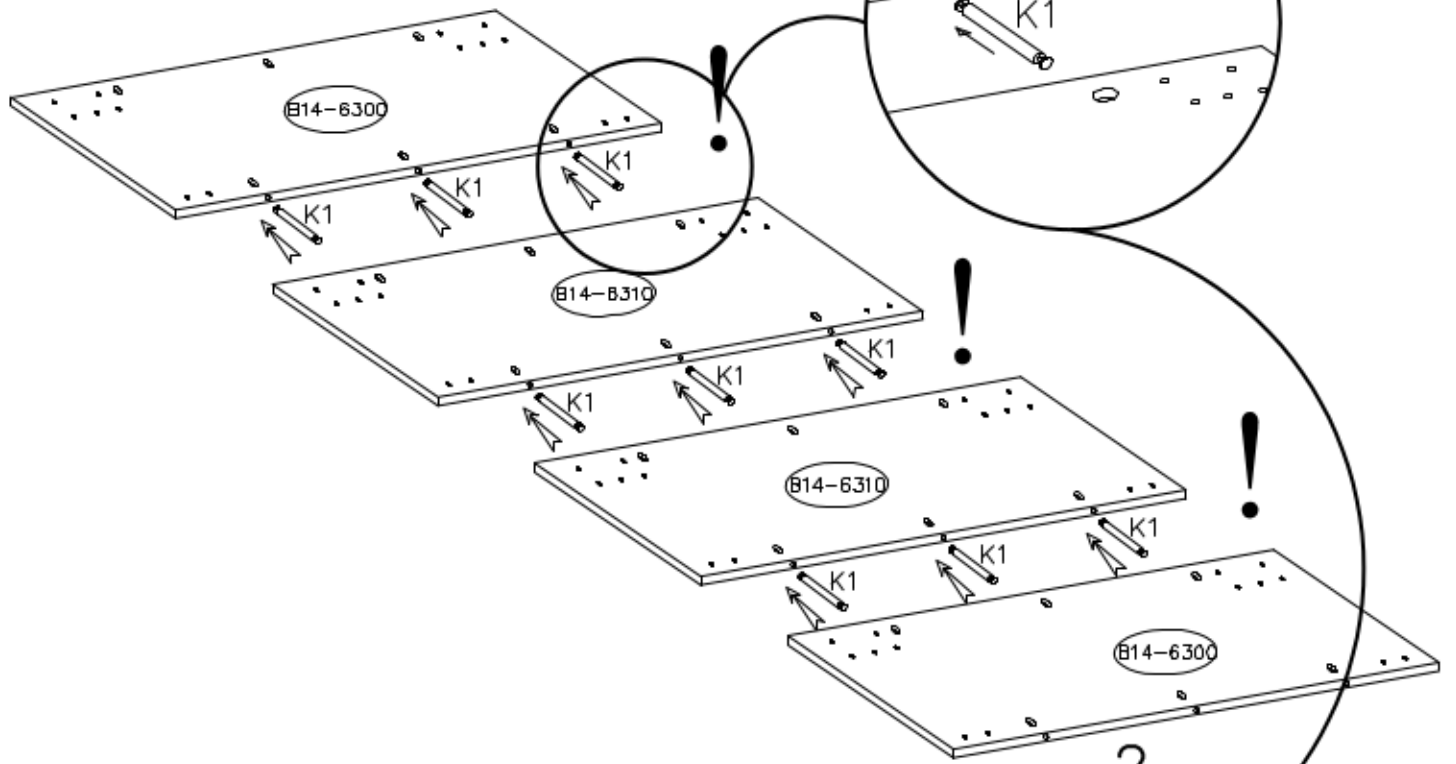

2

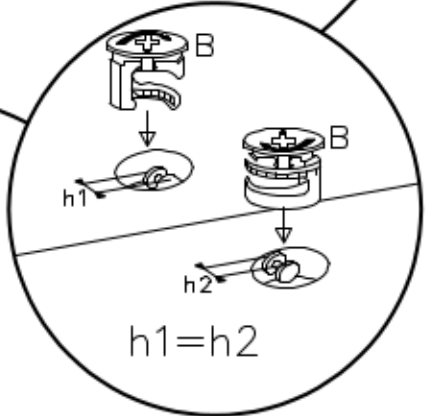

3

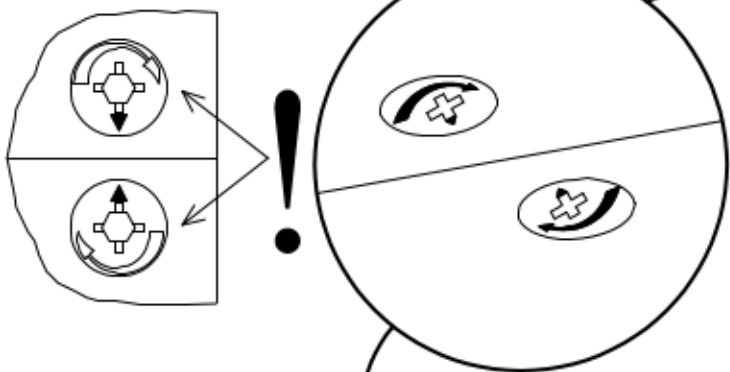

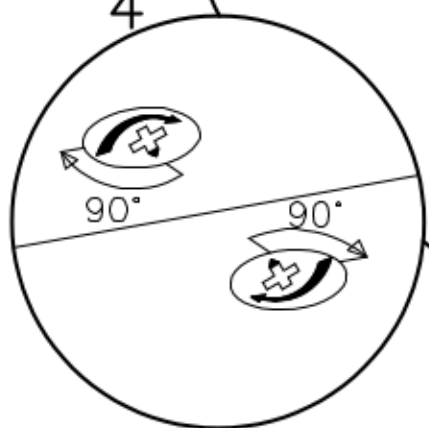

4

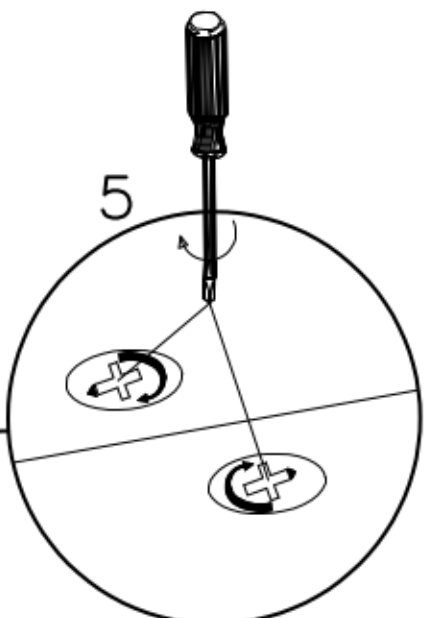

5





3.5x13		
 P1	V1	Q1
16	1	1

18b

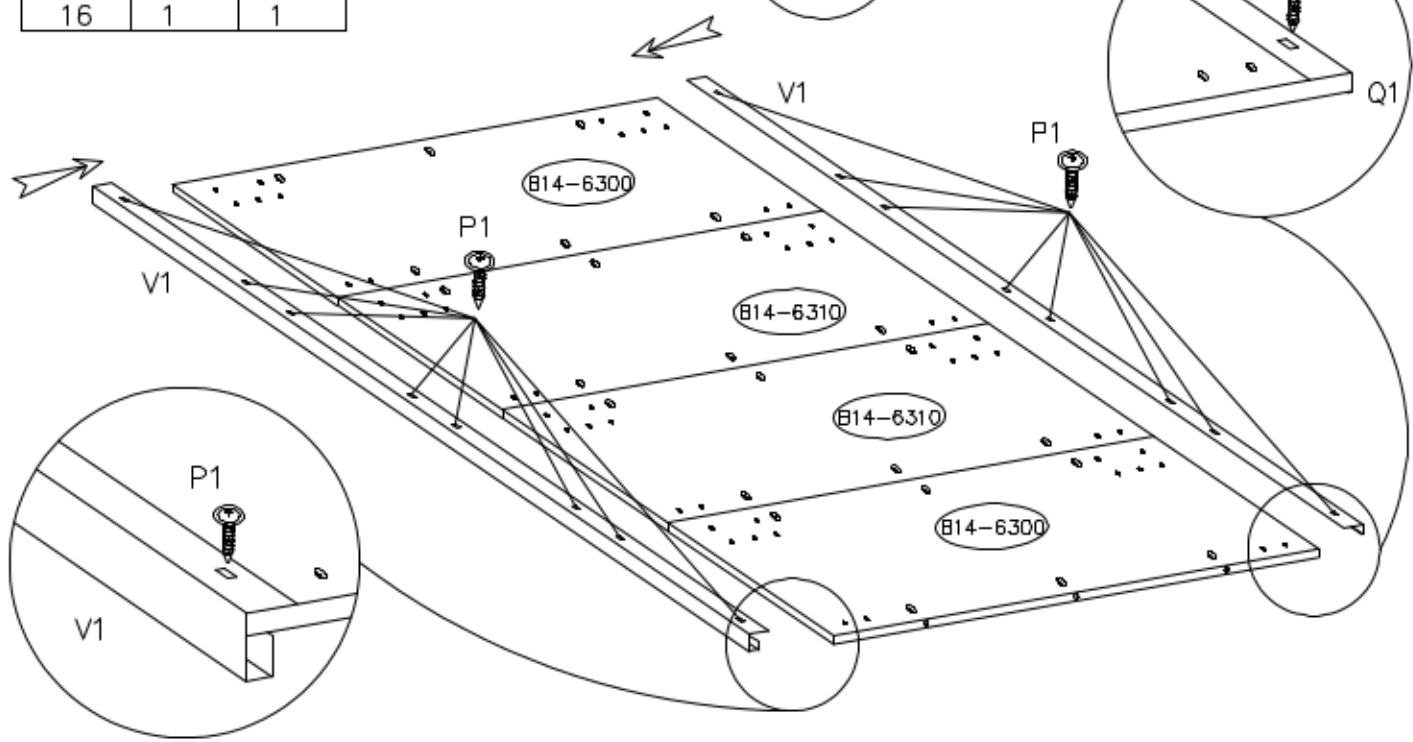
(R)



3.5x13		
 P1	V1	Q1
16	1	1

19b

(L)

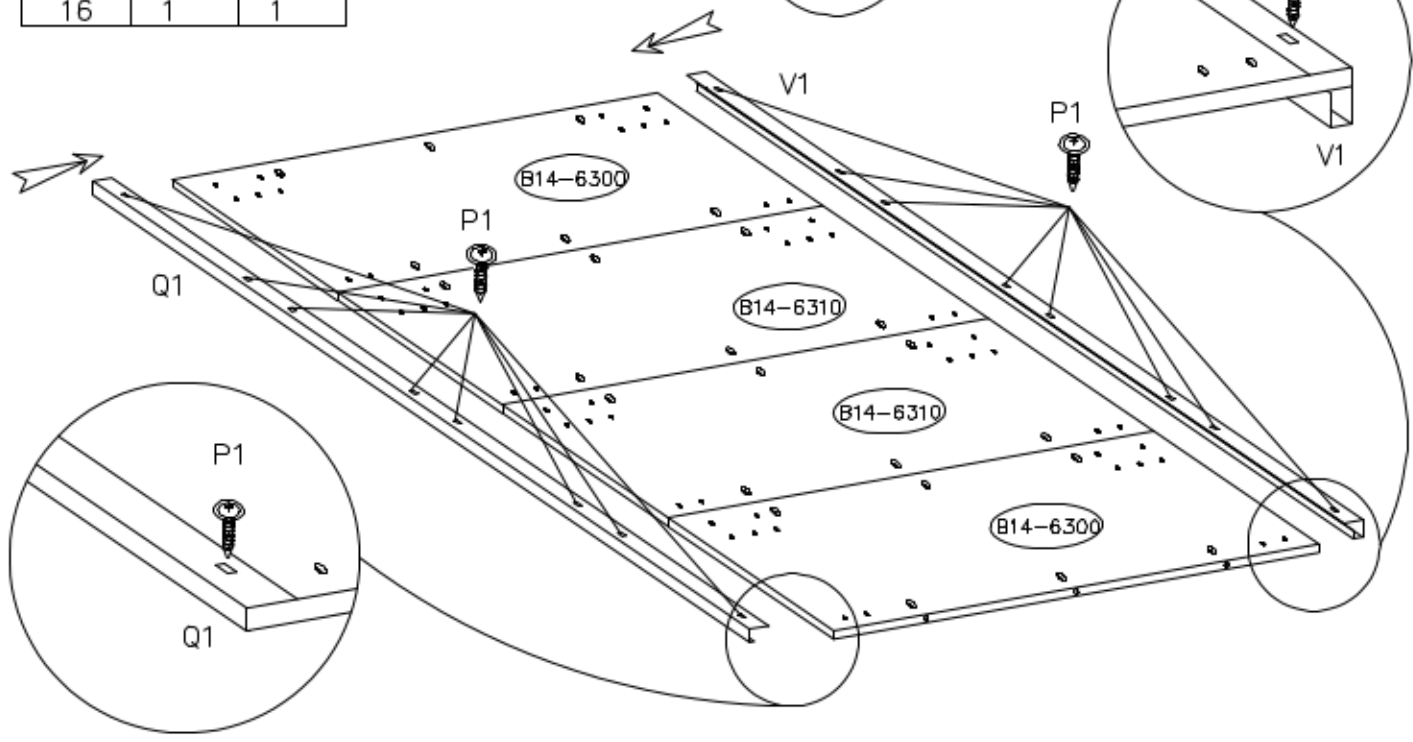

6.3x13 F	L	S	M
24	2	1	1
PCV C1	W	Z	
1	2	2	

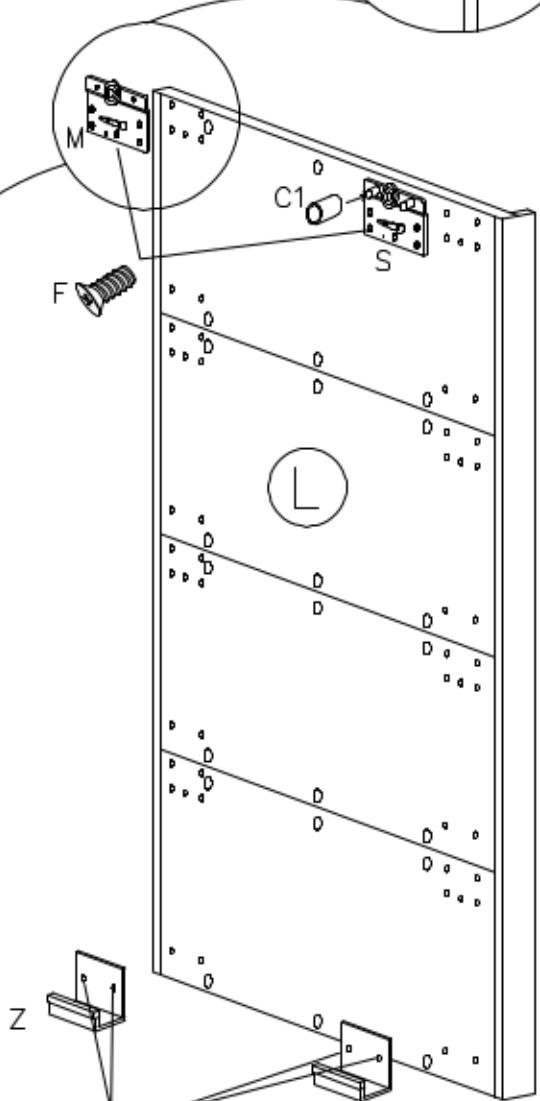
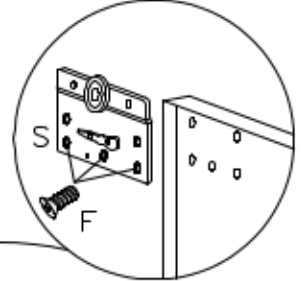
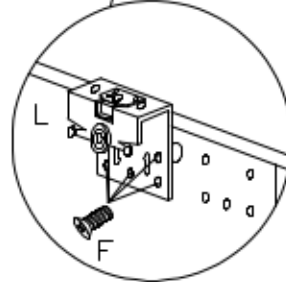
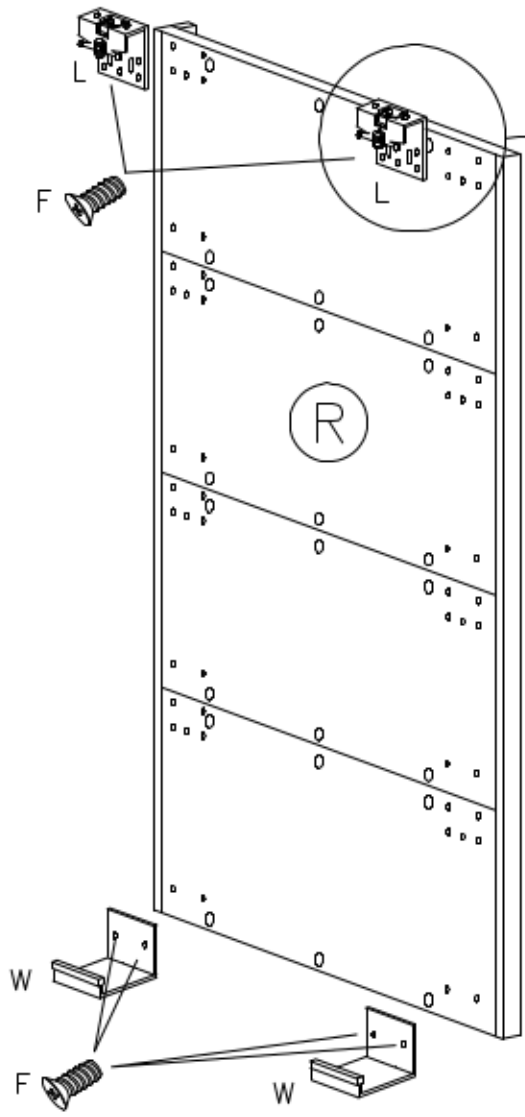

L

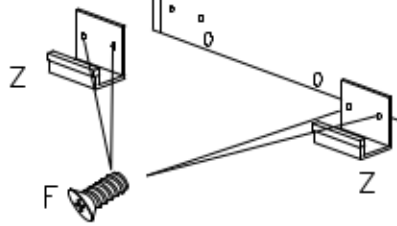
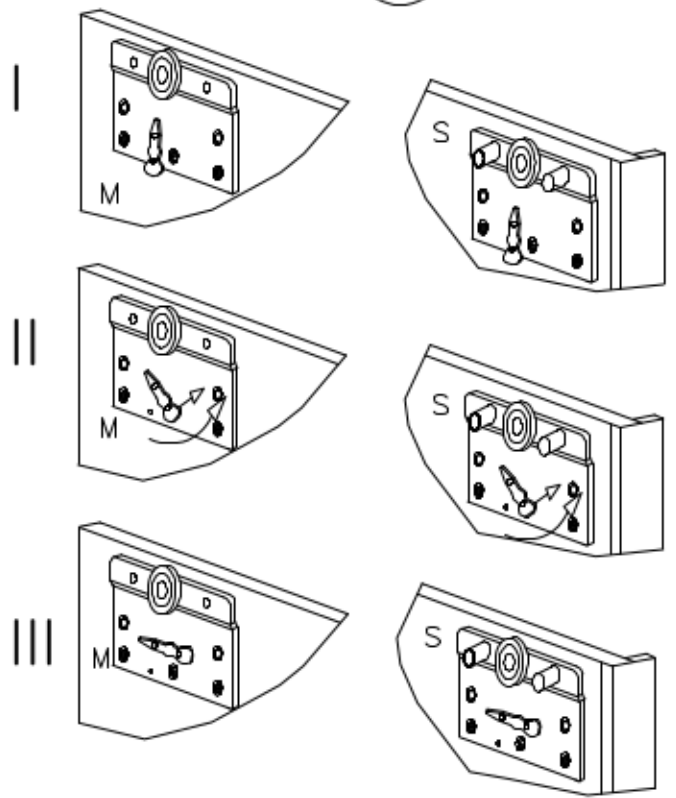

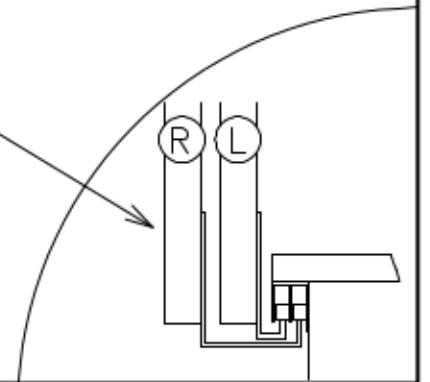
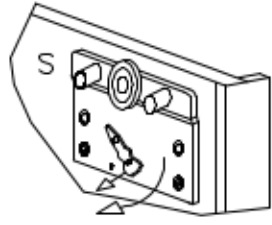
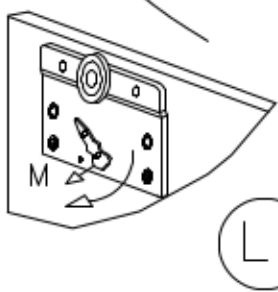
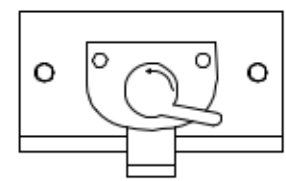
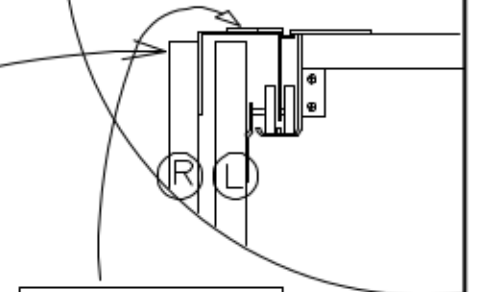
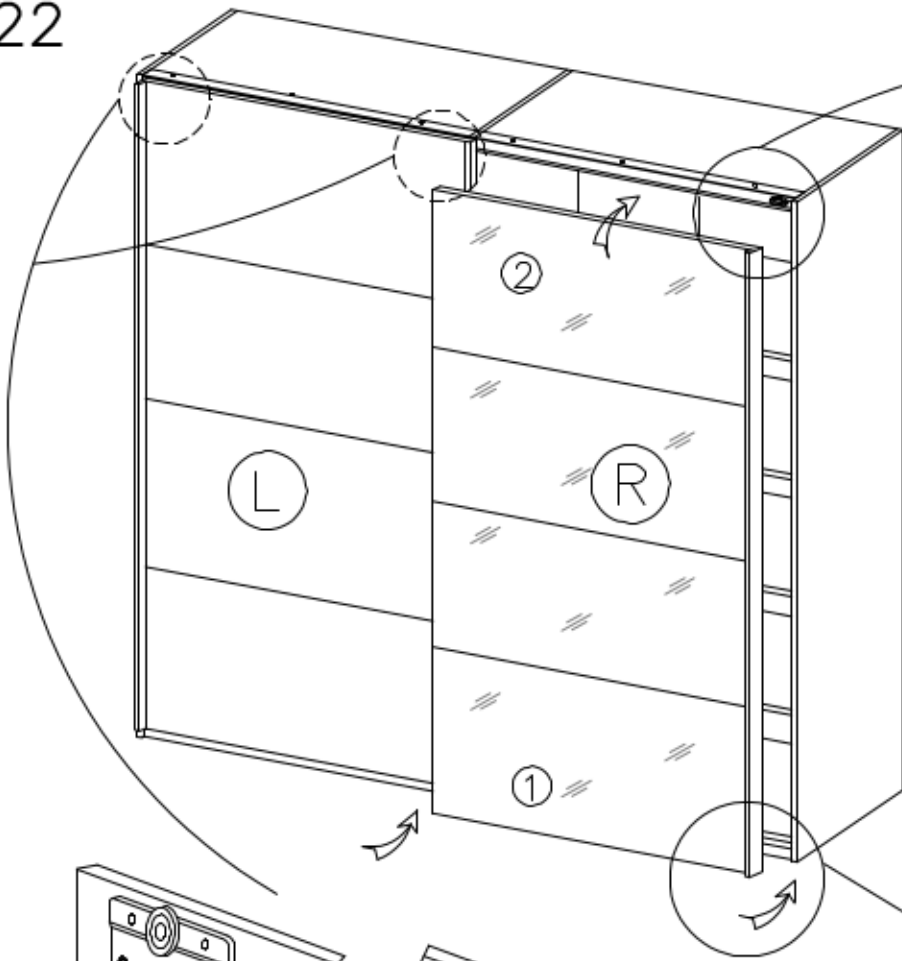
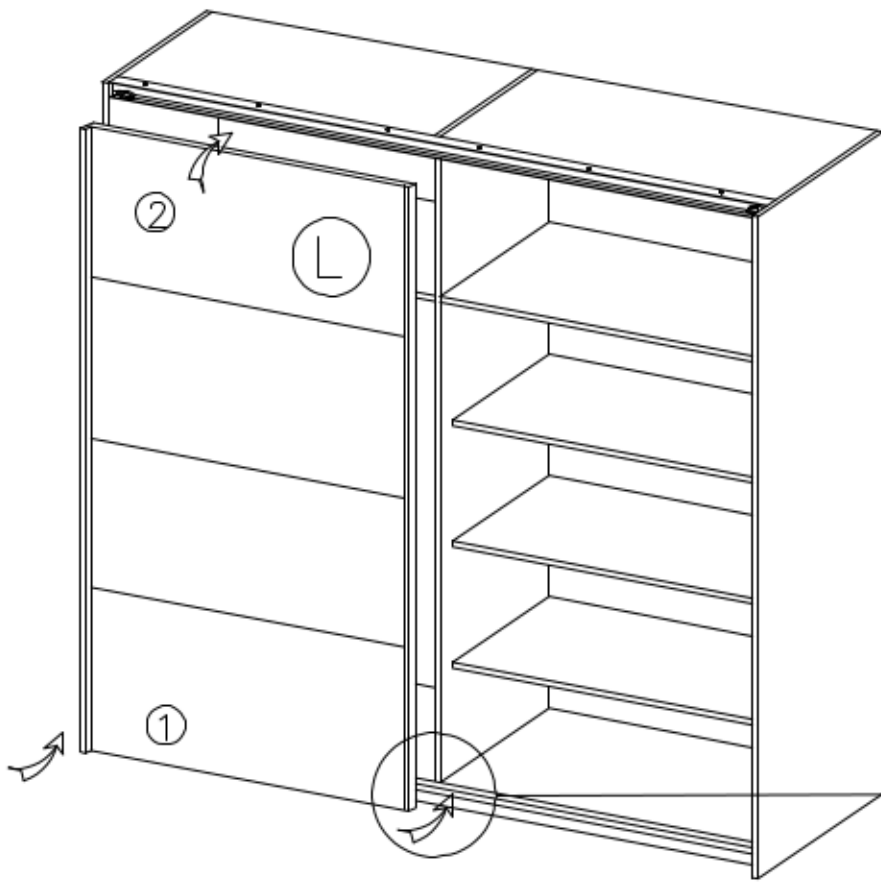

1



Uwaga • Upozornini • Achtung • Attention • Caution • Figyelem
Attenzione • Orgelet • Внимание • Atentie • Upozornenie • Dikkat



PL	Mocowanie do ściany jest jednocześnie zabezpieczeniem przed przewróceniem - koniecznie zamontować! Do niektórych rodzajów ścian koniecznie zastosować specjalne kołki mocujące.
CZ	Montáž na stěnu slouží jako ochrana proti převrnutí - bezpodmínečně umístěte! U některých typů stěn může být zapotřebí speciální hmoždinka!
D	Wandbefestigung dient als Kippschutz - unbedingt anbringen! Bei einigen Wandtypen kann ein Spezialdübel erforderlich sein!
GB	The wall fastening serves to prevent tipping - be absolutely sure to mount it! For certain wall types, a special wall plug may be necessary!
FR	La fixation murale sert de protection contre le basculement - à installer impérativement ! Pour certains types de murs il faut des chevilles spéciales !
NL	Bevestiging aan de muur dient als kantelbescherming - zeker en vast bevestigen! Bij enkele muurtypes is een speciale plug misschien vereist!
IT	Il fissaggio alla parete serve da protezione anti-ribaltamento - attaccarla assolutamente! Per alcune strutture di parete può essere necessario un tassello speciale!
HU	A termék a falhoz kel rögzítési, különben az felborulhat! Egyes falípusoknál speciális tiplét kell használni!
RU	Обязательно установите крепление на стене во избежание опрокидывания! Для некоторых типов стен может потребоваться специальная дюбель!
RO	Sistemul de fixare la perete servește ca protecție la răsturnare - de montat obligatoriu! Pentru unele tipuri de pereți este posibil să fie necesar un diblu special!
SK	Upevnenie na stenu slúži ako ochrana proti prevráteniu - bezpodmienečne použite! Pre niektoré druhy stien môže byť potrebná špeciálna hmoždinka!
TR	Duvardaki sabitleme, devrilmeye karşı bir emniyet tedbiridir ve mutlaka monte edilmelidir! Bazı duvar tiplerinde bunun için özel bir dübel gerekli olabilir!

2a

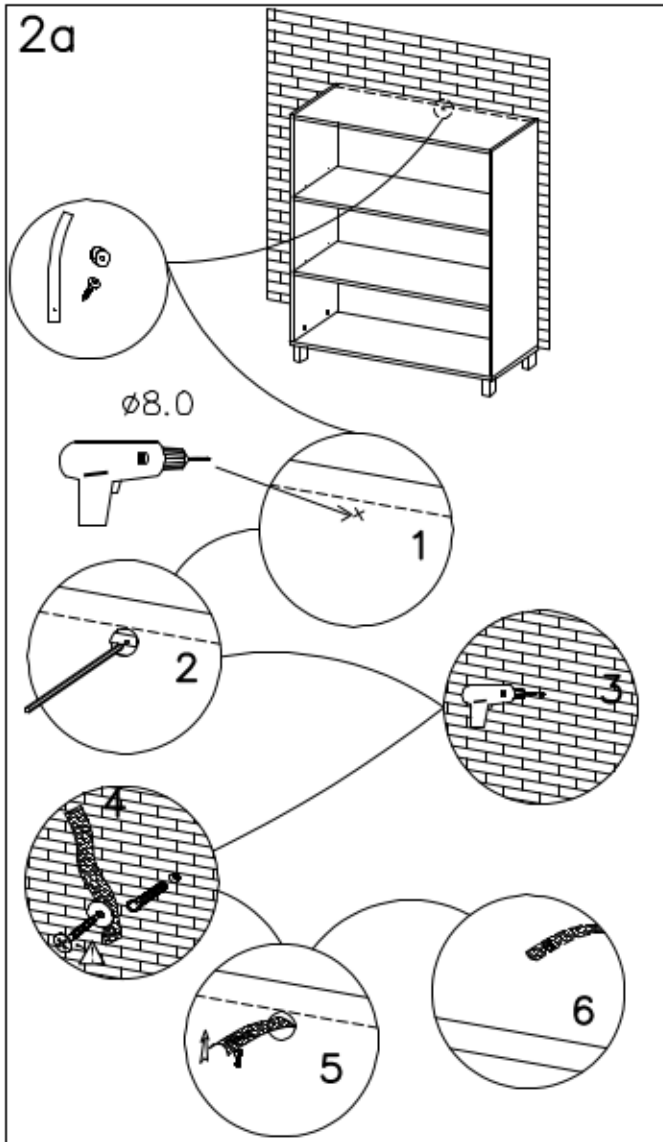

2b

