

PRZED ROZPOCZĘCIEM MONTAŻU ZAPOZNAĆ SIĘ Z INSTRUKCJĄ

Narzędzia niezbędne do montażu (nie dostarczane przez producenta)

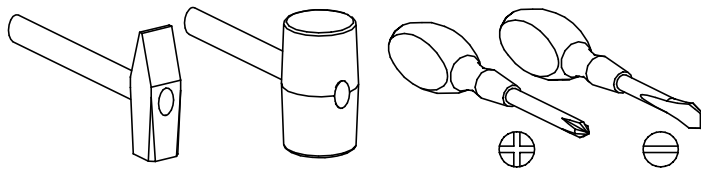

REGAŁ OTWARTY

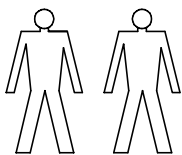
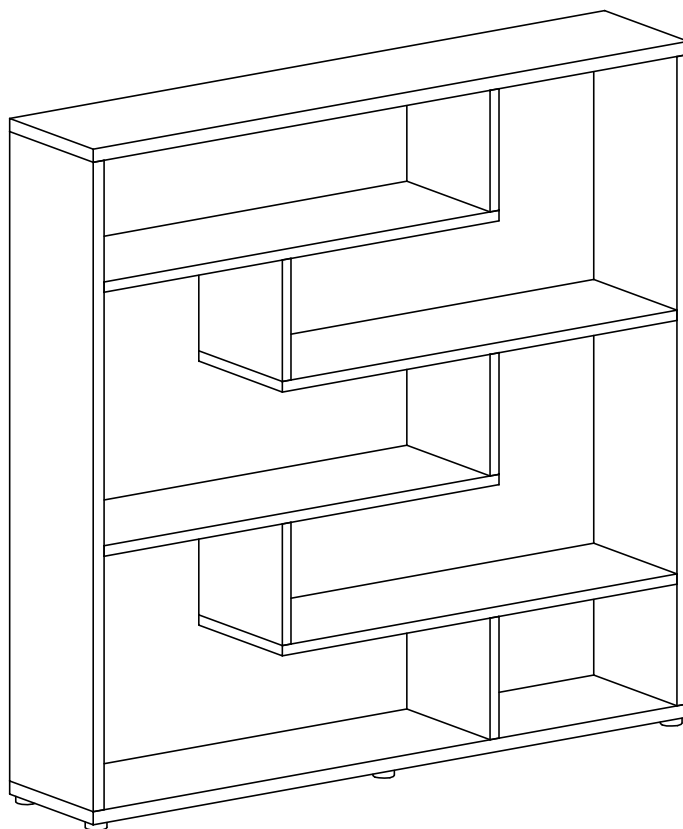

P19



x6

I7



x36

K5

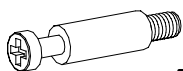

x36

K1



ø15 x 12 x36

B1

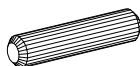

x36

W2

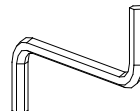

x1

G3



4 x 30 x6

I

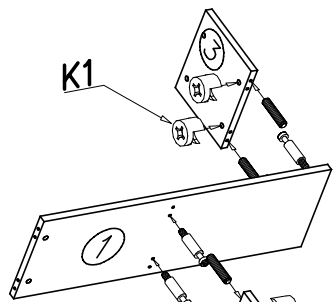

II

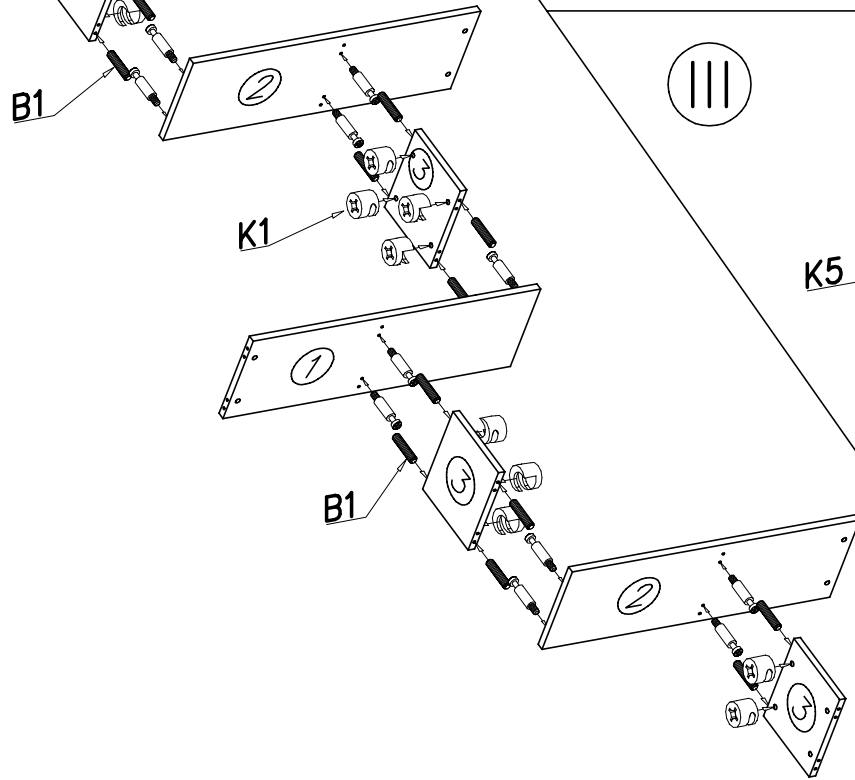
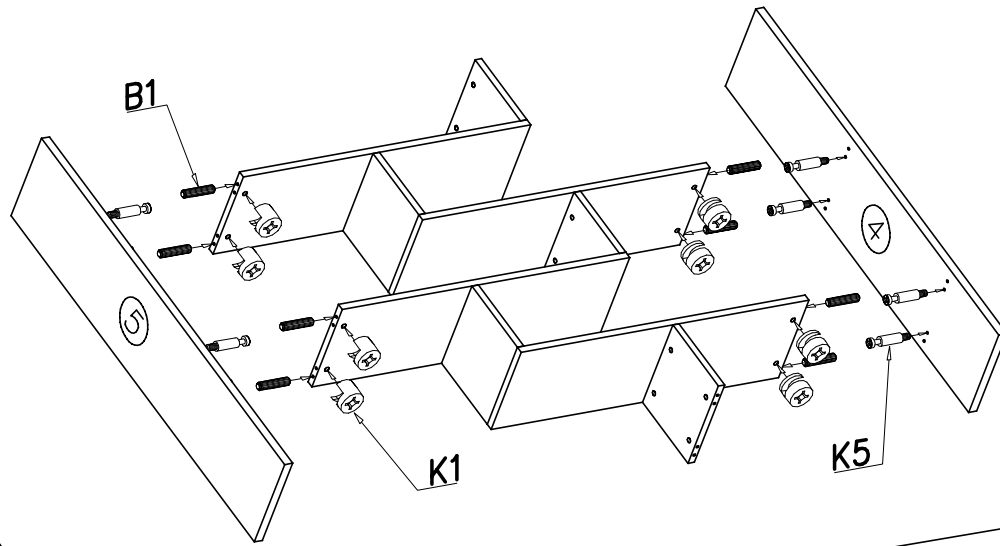

III

