

Art.-Nr.
244-0007/001
244-0007/002
v0

VALE

SK NAVOD NA MONTAZ
HU SZERELÉSI UTASÍTÁS
CZ MONTÁŽNÍ NÁVOD
HR UPUTE ZA UGRADNJU
FR GUIDE D'INSTALLATION
UA Інструкція з монтажу

DE MONTAGEANLEITUNG
PL INSTRUKCJE INSTALACJI
RO INSTRUCTIUNI DE INSTALAR
EN INSTALLATION GUIDE
IT GUIDA D'INSTALLAZIONE

1/10
1900
1000
380
mm

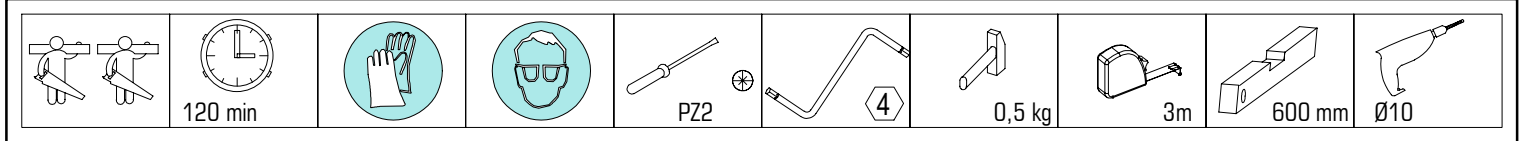

ID	ID	ID	ID	ID
18122	②	1900*380*16	1x	1/2
18285	③	143*358*16	2x	2/2
18034	④	1864*359*16	1x	1/2
18091	⑤	739*358*16	2x	2/2
18118	⑥	1864*359*16	1x	1/2
18137	⑦	362*50*16	2x	2/2
18152	⑧	735*50*16	4x	2/2
18039	⑨	984*360*16	1x	2/2
18113	⑩	984*360*16	1x	2/2
18103	⑪	1864*70*16	2x	1/2
18164	⑫	766*378*3	5x	1/2
18282	⑬	735*355*16	2x	2/2
18117	⑭	362*355*16	1x	2/2
18070	⑮	512*374*16	5x	1/2
18063	⑯	752*200*16	1x	2/2

ID	ID	ID	ID	ID
18024	⑰	752*200*16	1x	2/2
18078	⑱	374*200*16	1x	2/2
18161	⑲	300*120*16	3x	2/2
18157	⑳	300*120*16	3x	2/2
18165	㉑	677*120*16	2x	2/2
18083	㉒	304*120*16	1x	2/2
18029	㉓	306*705*3	2x	1/2
18081	㉔	306*332*3	1x	1/2

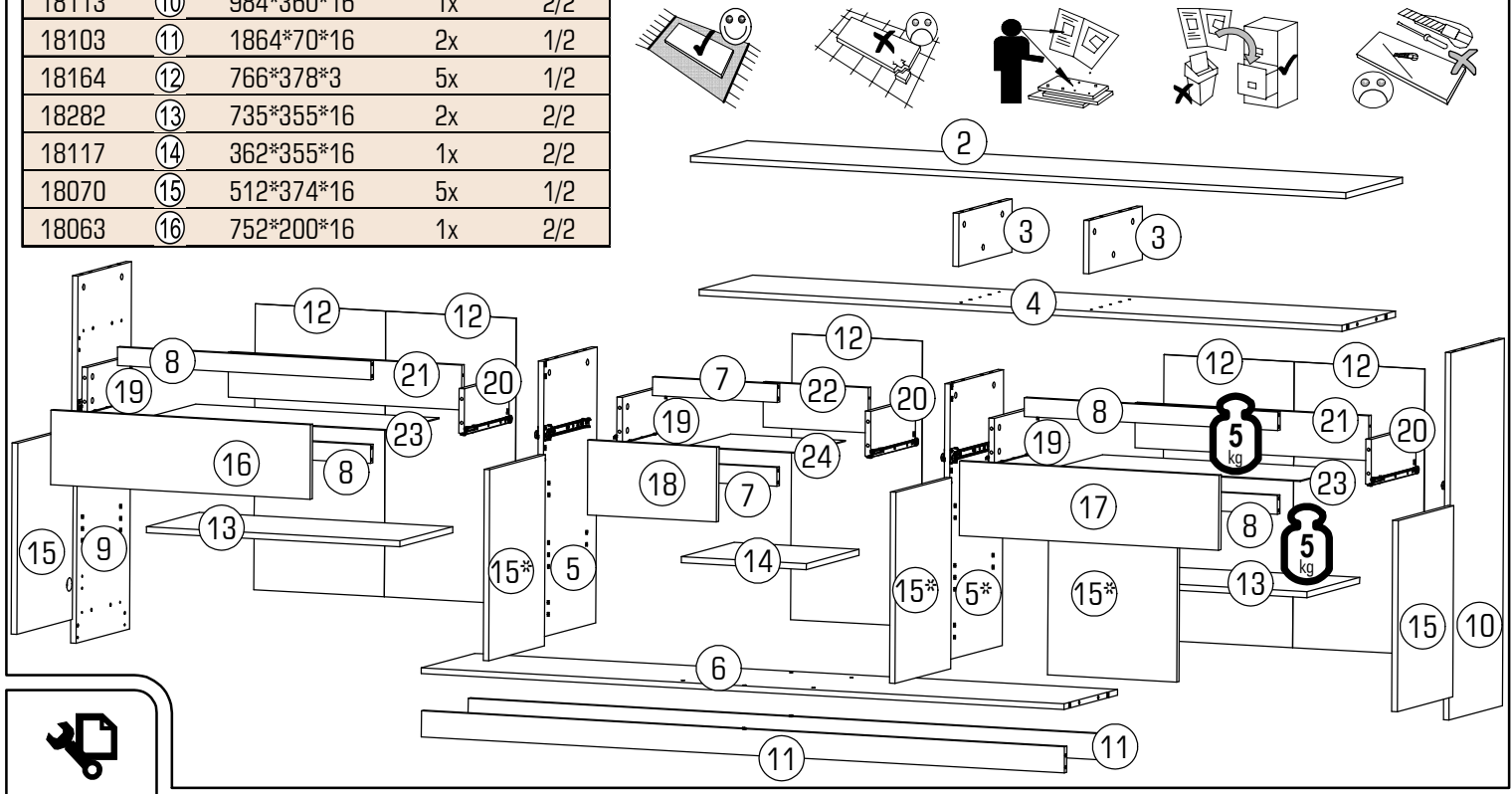
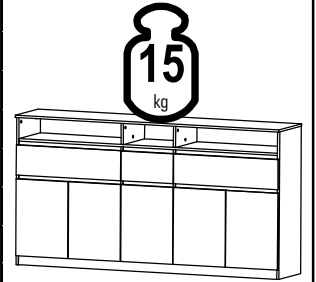



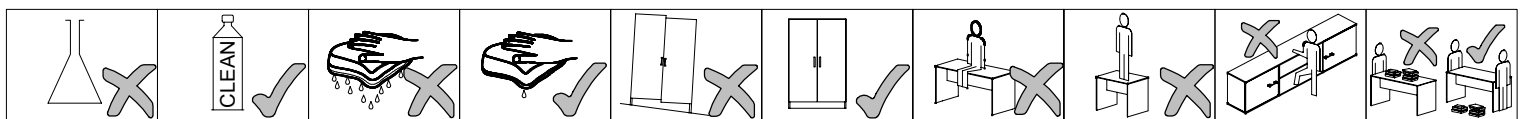

0	10	20	30	40	50	60	70	mm	21102,00	22256,00	30091,00	22243,00	22244,01	22300,00																	
A	50x	B	2x	C	8x	D	44x	E	17x	F	18x	G	4x	H	4x	J	12x	K	2x	L	52x	M	2x	N	12x	P1	38x	P2	18x	P3	4x
70021,01	36002,07	36002,07	33003,00	33003,00	22800,01	36013,02	36013,02	24008,00	22336,00	Q	38x	R1	4x	R2	4x	U1	3x	U2	3x	V	1x	W1	6x	W2	6x	X1	14x	X2	14x		



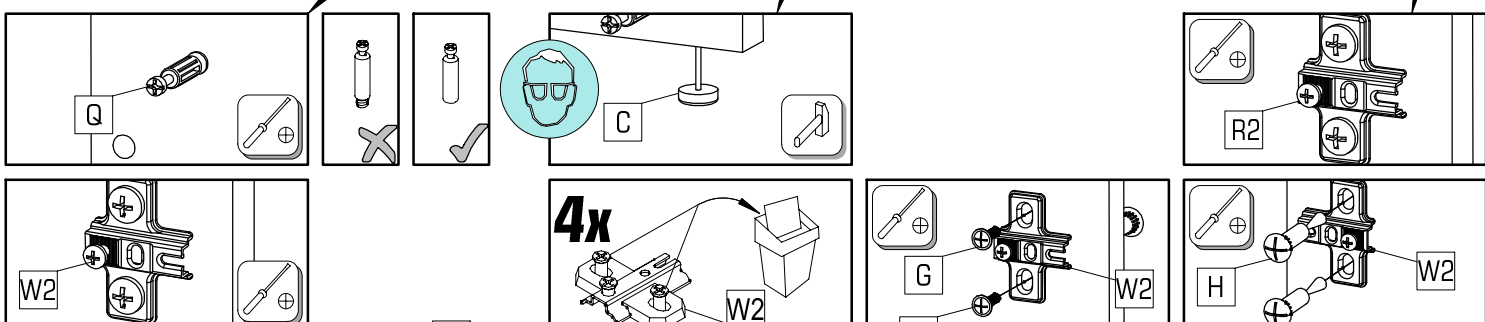
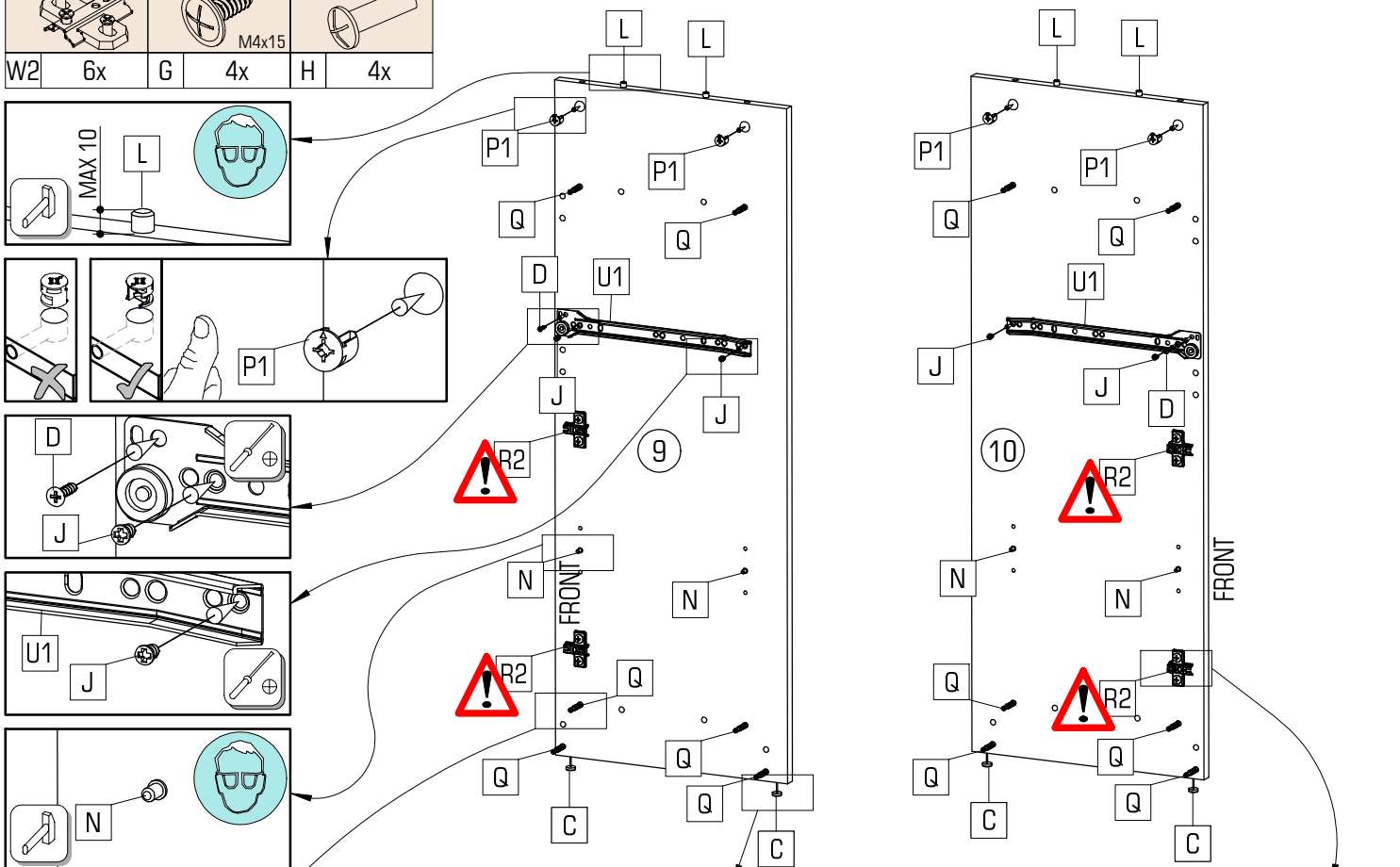
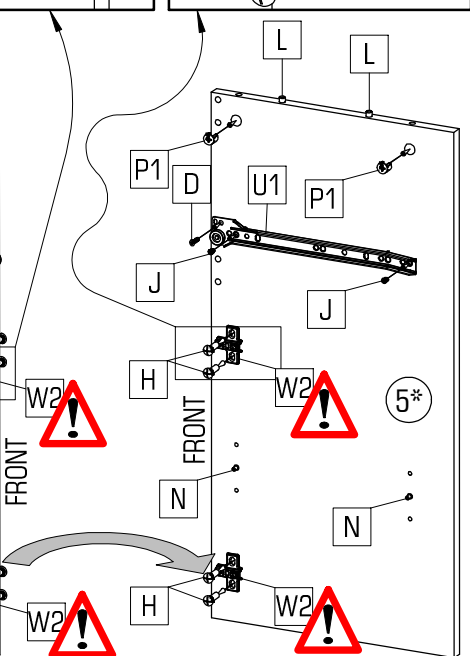
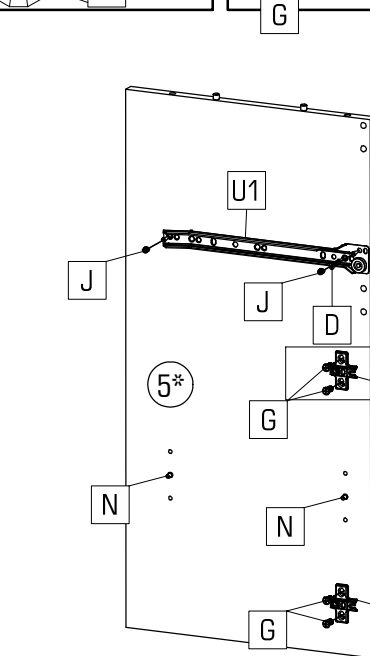
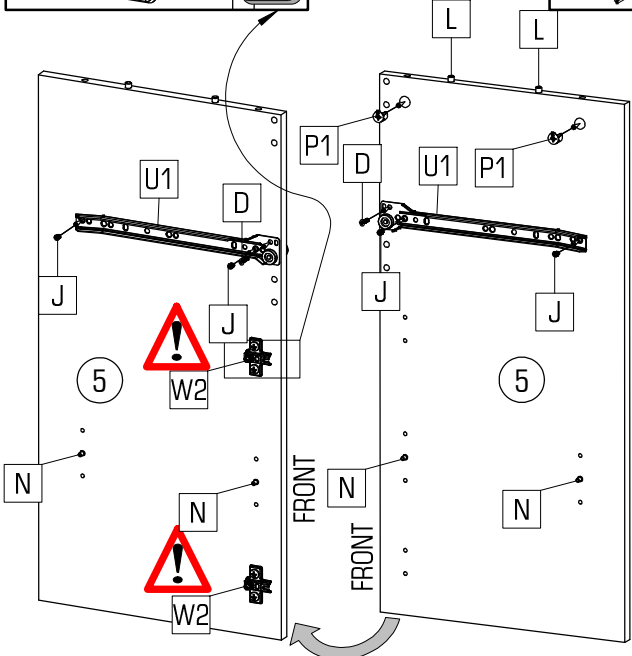
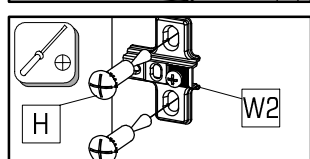
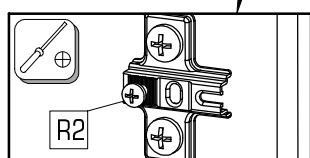
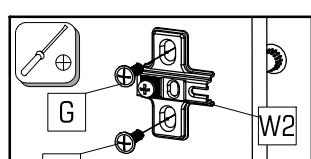
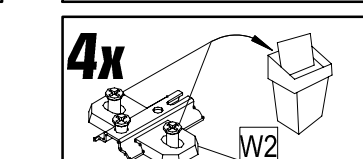
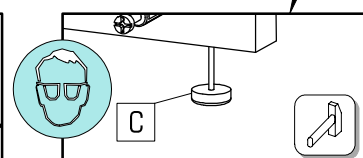
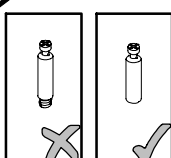
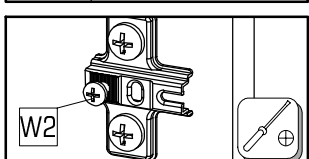
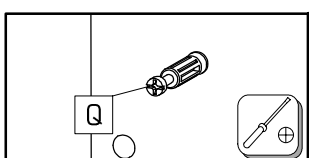
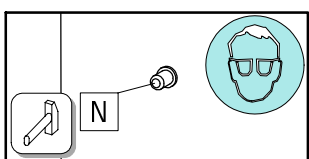
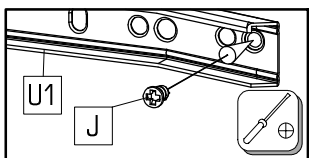
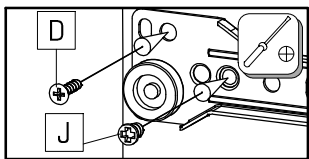
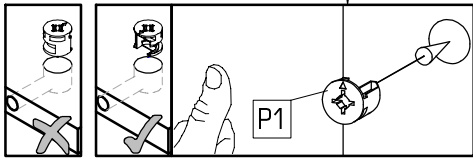
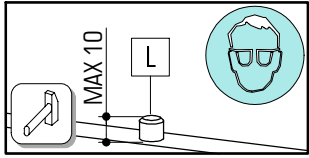

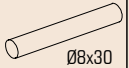

C 4x	D 6x	J 12x	L 8x	N 12x	P1 8x	Q 12x	R2 4x	U1 3x

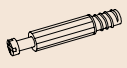
W2 6x	G 4x	H 4x

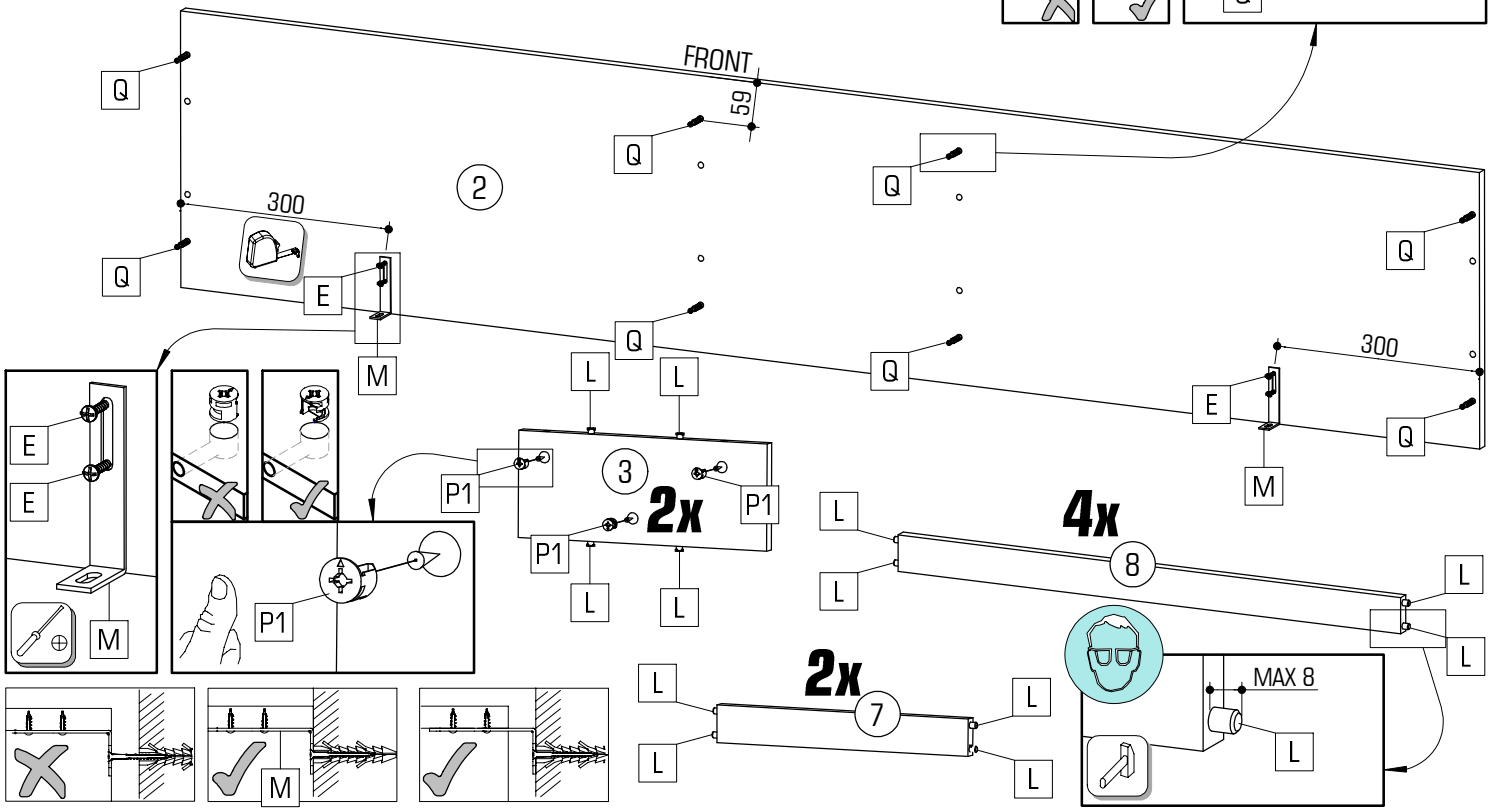
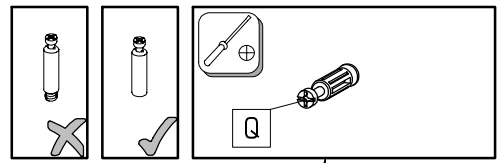

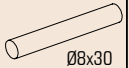

				
E 4x	L 32x	M 2x	P1 6x	Q 8x

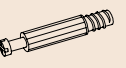

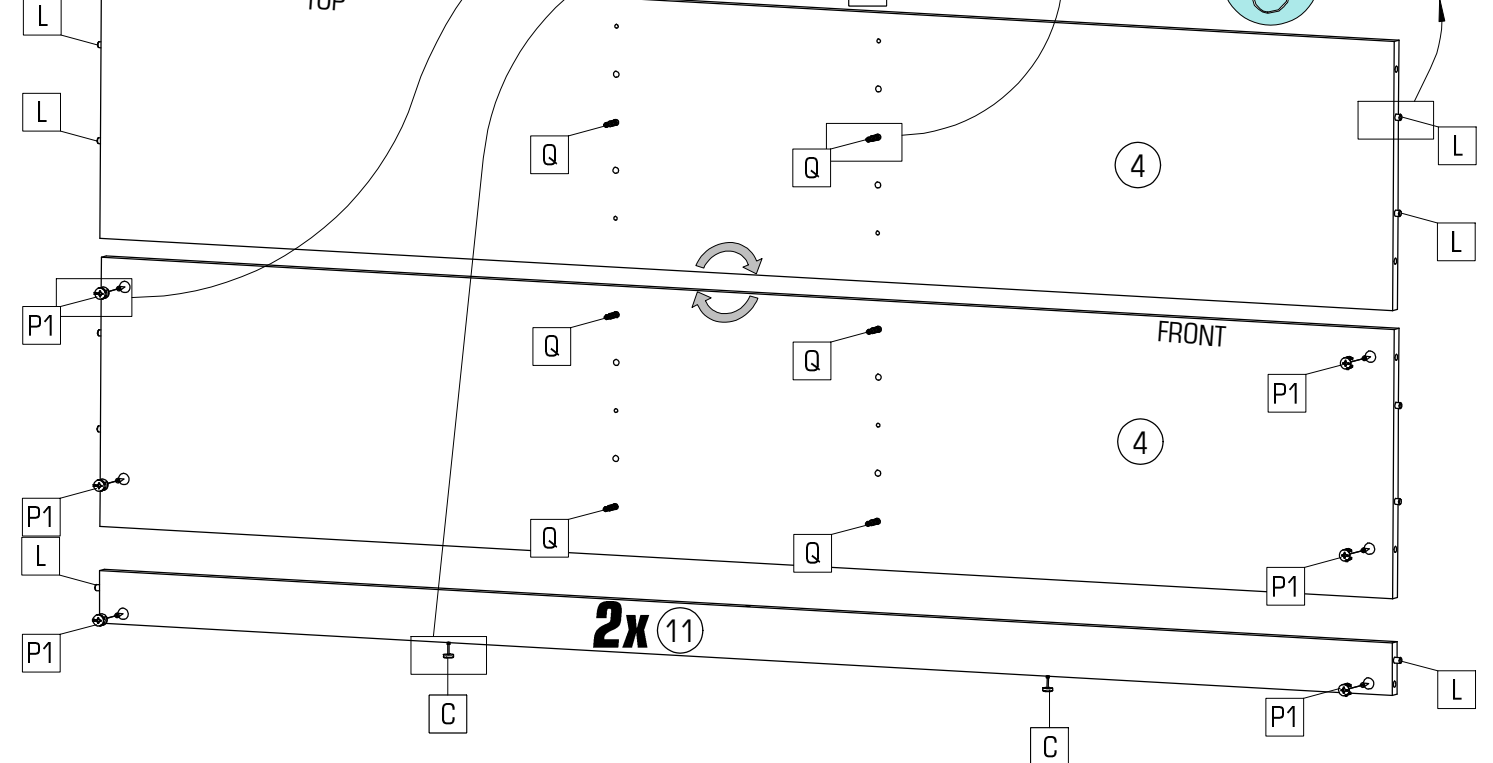
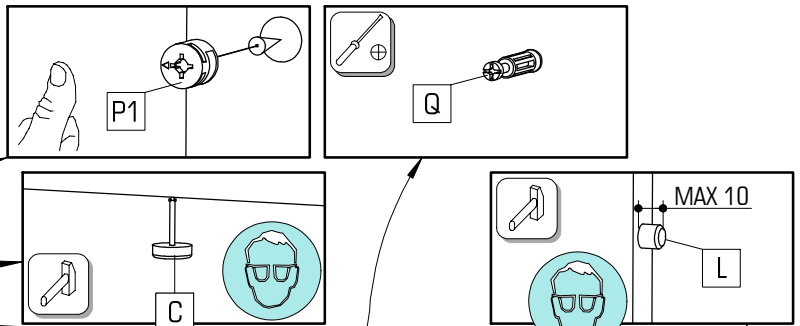

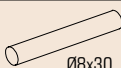
			
C 4x	L 8x	P1 8x	Q 6x

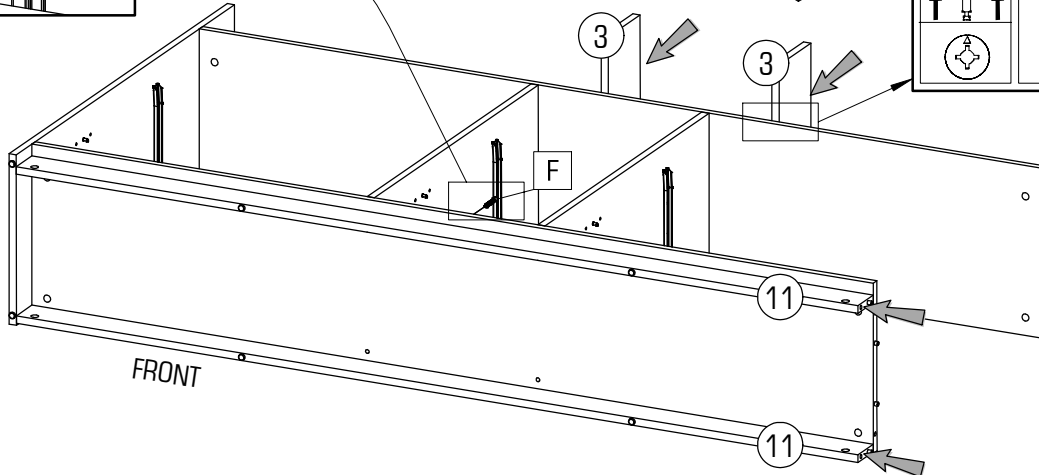
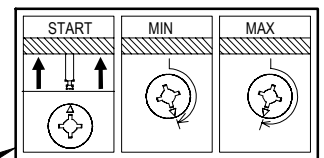
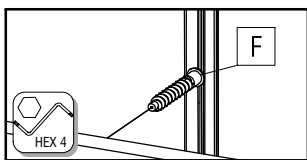
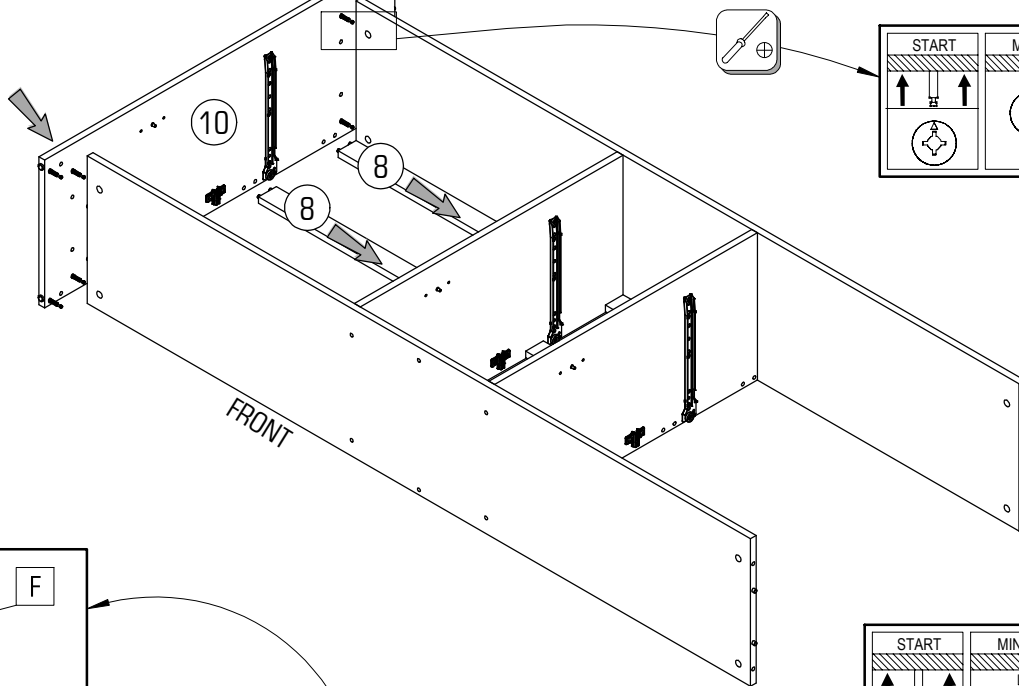
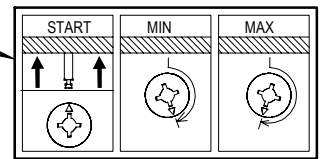
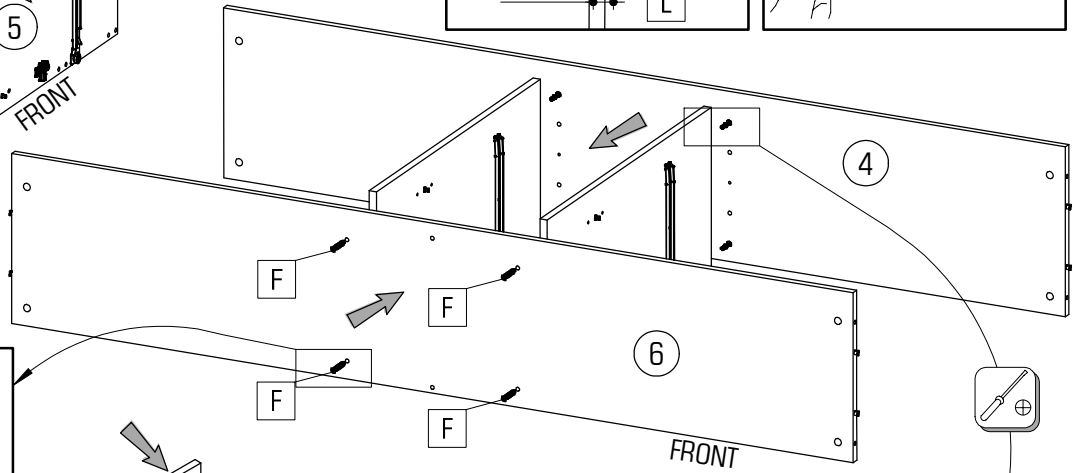
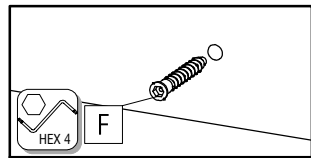
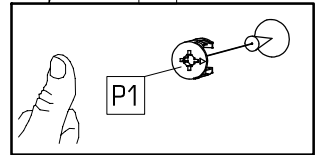
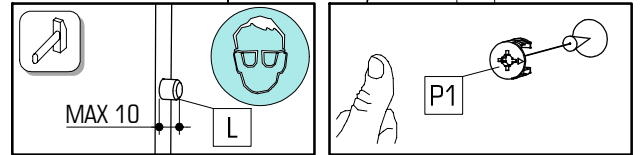
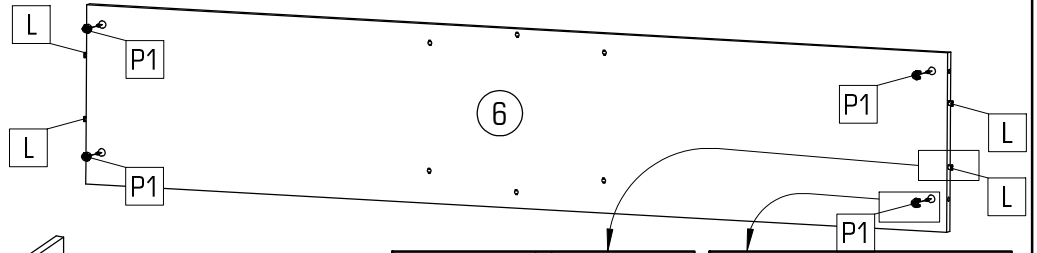
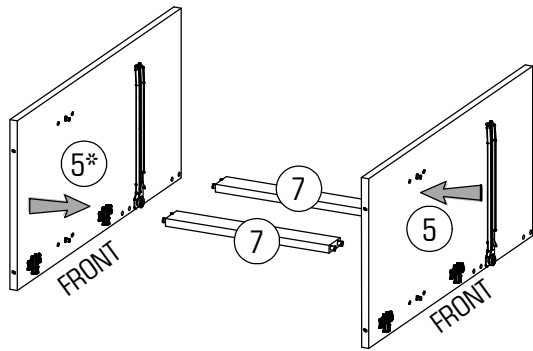

		
Ø7x50	Ø8x30	Ø15x13
F 6x	L 4x	P1 4x

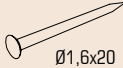

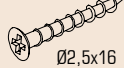
		
Ø1,6x20	3,0	Ø2,5x16
A 50x	X1 14x	X2 14x

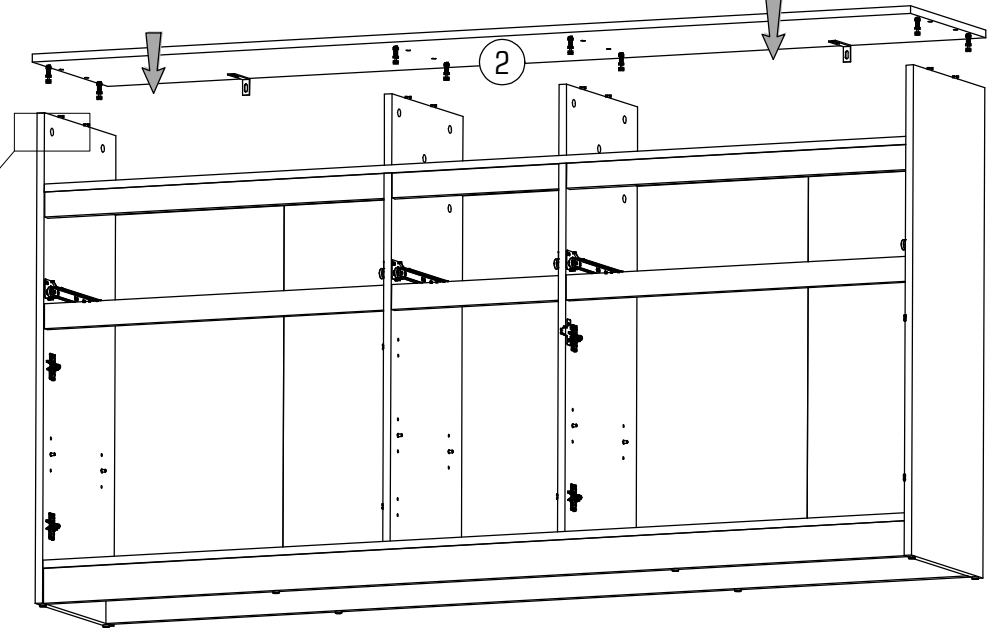
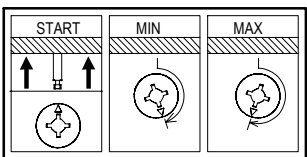
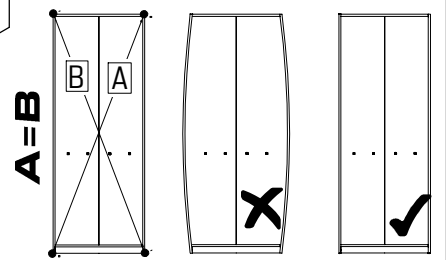
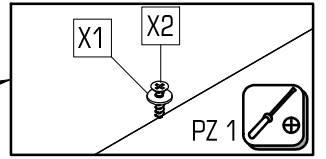
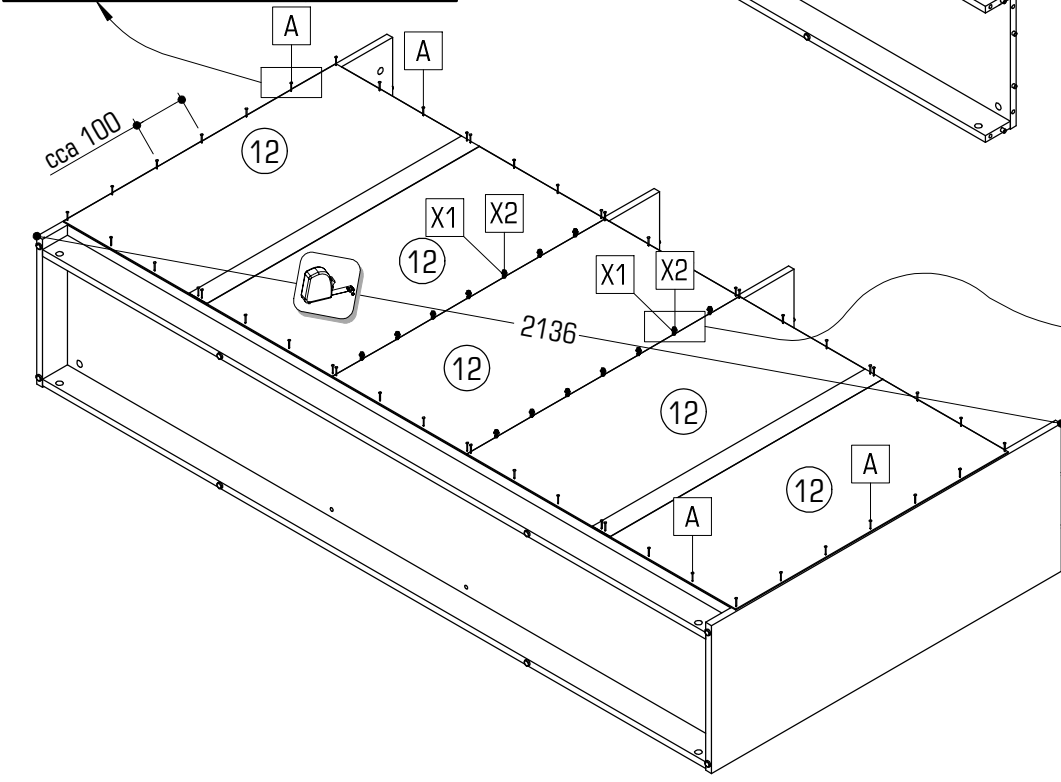
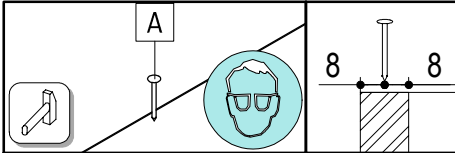
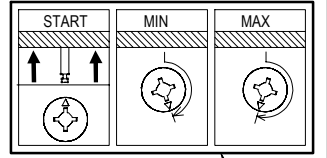



Upozornenie! Pevnosť steny sa musí pred montážou bezpodmienečne skontrolovať. Hmoždinky, ktoré sú v balení, používajte jedine pre pevné murivo ako je betón alebo tehla. Hmoždinky sa nesmú používať v prípade ľahkého stavebného muriva, dutinová tehla, sádkartónové dosky alebo iných konštrukcií rámu. U týchto murív je nutné použiť špeciálne hmoždinky! Tieto je možné dostať v predajniach so stavebným materiálom (stavebniny). Pri nedodržaní pokynov nepreberajú výrobcovia/predajci a dodávatelia zodpovednosť za vzniknuté škody.

Upozornění! Před montáží je nutné zkontrolovat stav stěny. Příložené hmoždinky jsou určeny pouze k použití pro pevné zdivo jako beton/cihly. Hmoždinky do zdi se nesmí používat u dutinová cihla, zdiva jako pórovitý stavební kámen, sádkartónová deska nebo jiný měkký materiál. U těchto zdív jsou nutné použít speciální hmoždinky! Jsou k dostání v prodejních se stavebním materiálem. Při nedodržení těchto pokynů výrobce/prodejce a dovozce neručí za způsobené škody.

Pažnja! Prije montaže obvezno provjerite svojstvo zida. Priložene univerzalne tiplje namijenjene su isključivo za masivne zidove od betona/opeke. Tiplje za masivne zidove ne smiju se koristiti za zidove kao npr šupljina opeka laki sastavni elementi, gips-kartonske ploče ili drugi modularni načini gradnje. Za te zidove potrebne su eventualno specijalne tiplje! Iste su dostupne u trgovinama građevinskim materijalom. U slučaju nepridržavanja prethodno navedenih napomena, proizvođač/trgovac i uvoznik ne preuzimaju odgovornost!

Achtung! Die Wandbeschaffenheit ist vor der Montage unbedingt zu prüfen. Die beigelegten Universaldübel sind ausschließlich nur zur Verwendung für festes Mauerwerk wie Beton/Ziegel. Die Mauerdübel dürfen nicht bei Mauerwerk wie Hohlraumziegel, Leichtbausteinen, Gipskartonplatte oder anderer Rahmenbauweise verwendet werden. Bei diesen Mauerwerken sind gegebenenfalls Spezialdübel zu verwenden! Diese sind in einem Fachgeschäft (Baumarkt) erhältlich. Bei Nichteinhaltung wird seitens Produzenten/Händler und Importeur keine Haftung übernommen.

Vigyázat! Szerelés előtt a falfelület feltétlenül vizsgálja meg. A mellékelt univerzális tiplik kizárólag stabil falazathoz használható mint például beton/tégla. A fali tiplje nem használható könnyű építőkövekhez, üreg téglák, gipszkarton lapokhoz vagy más fűvázás építményekhez. Ezekhez a falfelületekhez csak speciális tiplik használhatóak, melyek szaküzletekben (barkácsruházakban) beszerezhetőek. Fentiek figyelmen kívül hagyása esetén a gyártó/kereskedő vagy forgalmazó nem vállal felelősséget.

Uwaga! Ścianę należy sprawdzić przed montażem. Dołączone uniwersalne kołki rozporowe są odpowiednie tylko do stosowania w mocnych murach, takich jak beton lub cegła. Nie robć za pomocą kołków rozporowych murowanych, takich jak pustak, lekka kostka, powierzchnie takie jak płyty gipsowo-kartonowe lub inne systemy ram. Jeśli dotyczy, muszą to być określone kołki rozporowe być użyty! Są one dostępne w specjalistycznym sklepie (sklepie ze sprzętem) niezgodność, producent / sprzedawca lub importer nie ponoszą odpowiedzialności.

Prudență! Zidul trebuie examinat înainte de asamblare prizele de perete sunt adecvate numai pentru utilizarea în zidărie feră, cum ar fi betonul, bloc sau cărămidă. Nu folosiți zidăria zidurilor de perete, cum ar fi cărămida goală, blocul ușor, suprafețe cum ar fi gips-carton sau altă încadrare sisteme. Dacă este cazul, trebuie folosite anumite prize de perete! Acestea sunt disponibile la un magazin specializat (magazin de hardware). În caz de nerespectare, producătorul / vânzătorul cu amănuntul sau importatorul nu își asumă răspunderea.

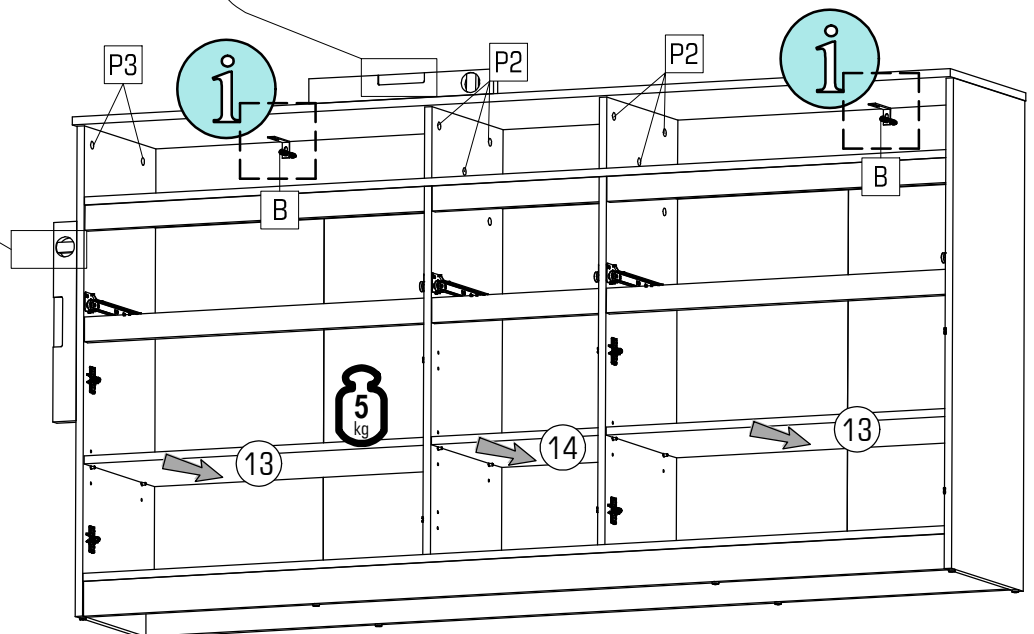
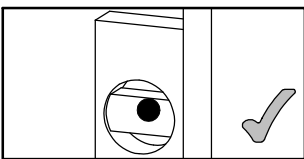
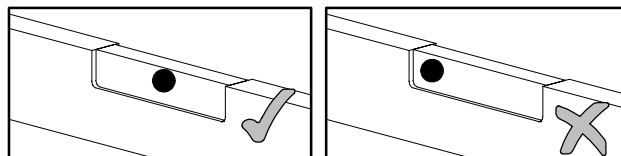
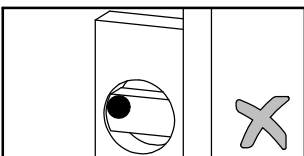
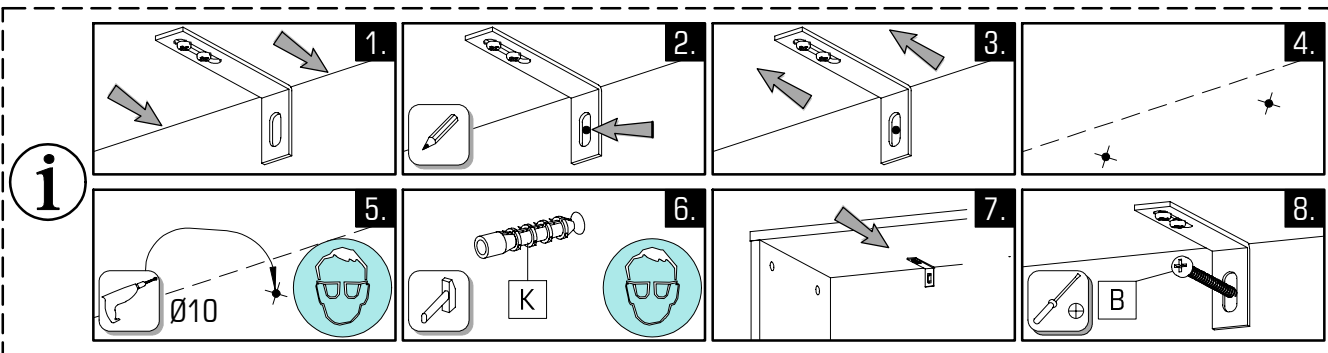
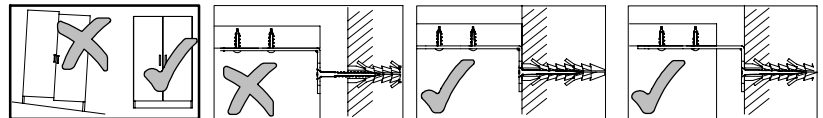

Увага! Стан стіни необхідно перевірити перед установкою. Укладені універсальні дюбелі призначені лише для використання з фіксованими Кладка, як бетон / цегла. Анкери для стін не повинні використовуватися для кладки Порожни цегли, легкі будівельні блоки, гіпсокартон або інша каркасна конструкція бути використаними. З цієї кладкою можуть застосовуватися спеціальні дюбелі використання! Вони доступні в спеціалізованому магазині (магазині апаратних засобів) Виробник / дилер та імпортер не несе відповідальності.

Ø5,0x70	Ø10		
B	K	P2	P3
2x	2x	6x	4x

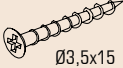
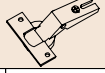

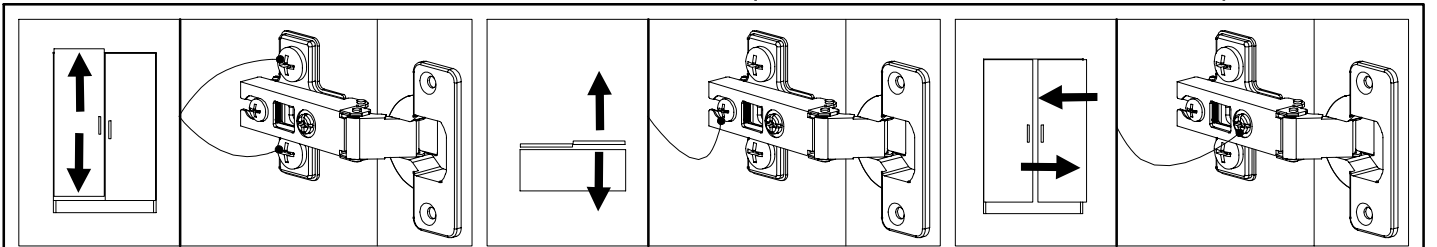
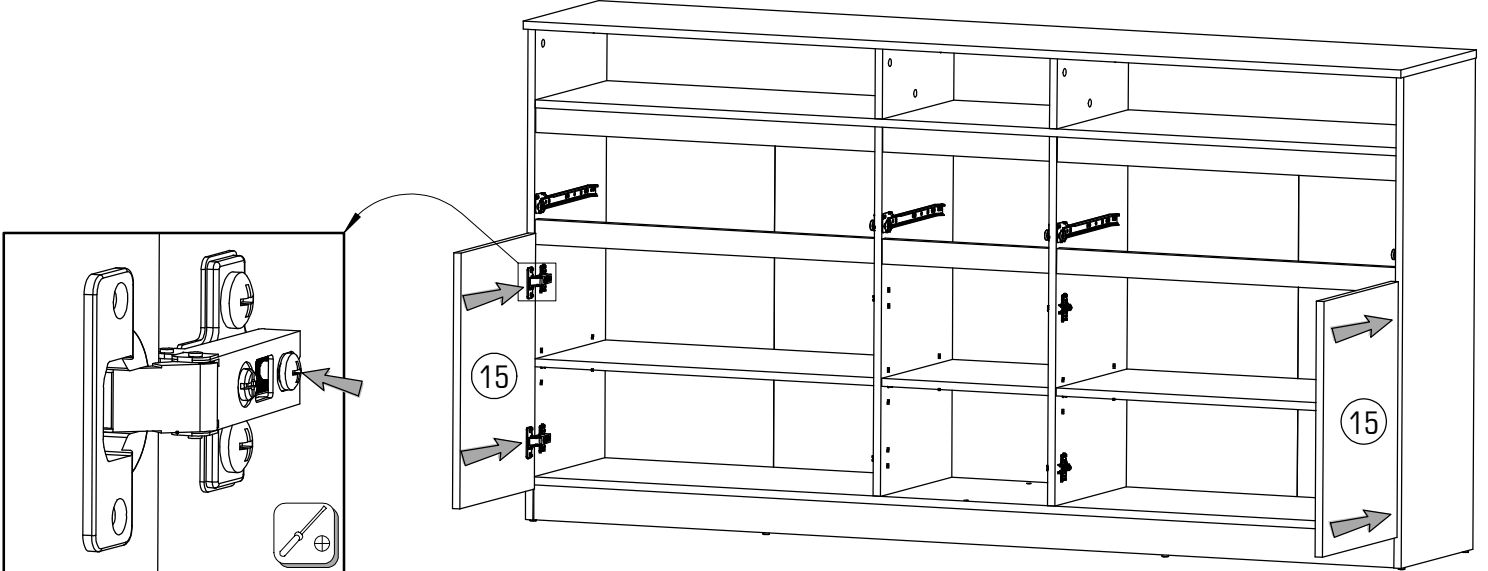
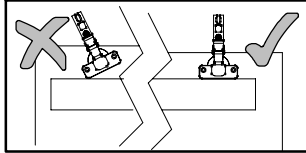
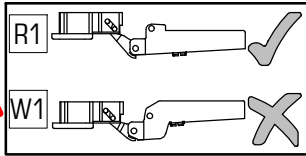
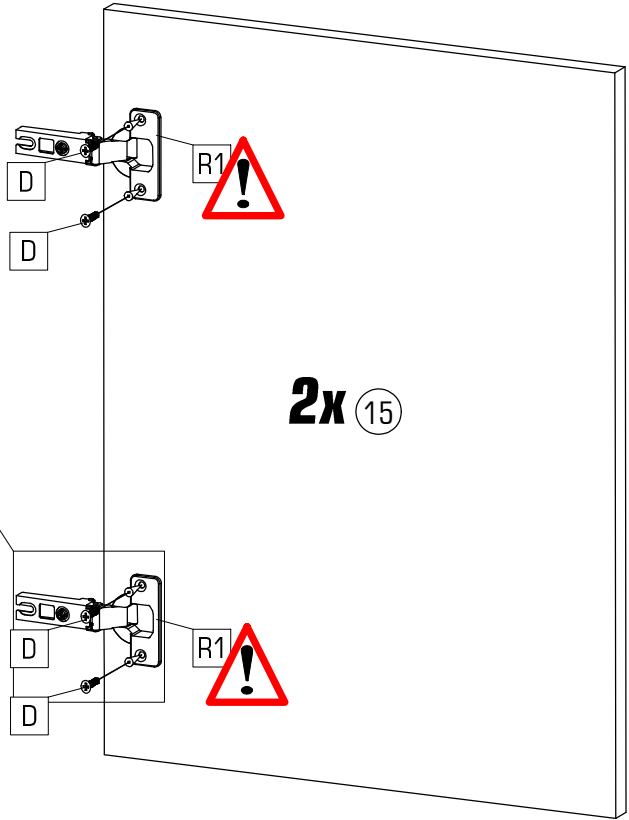
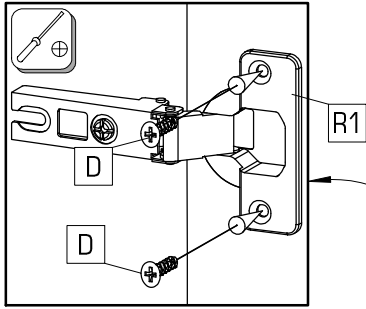

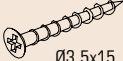

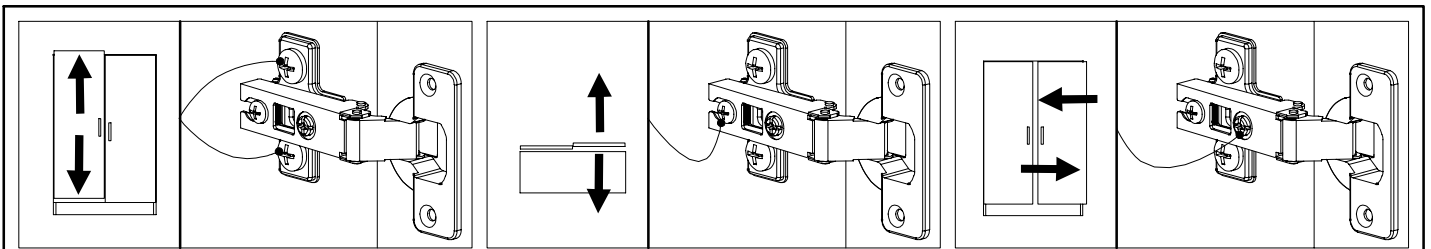
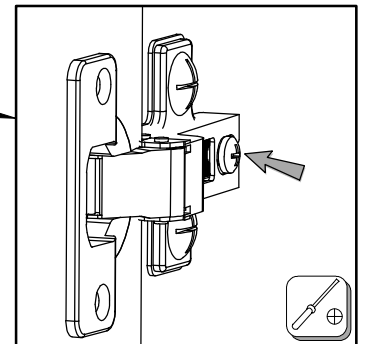
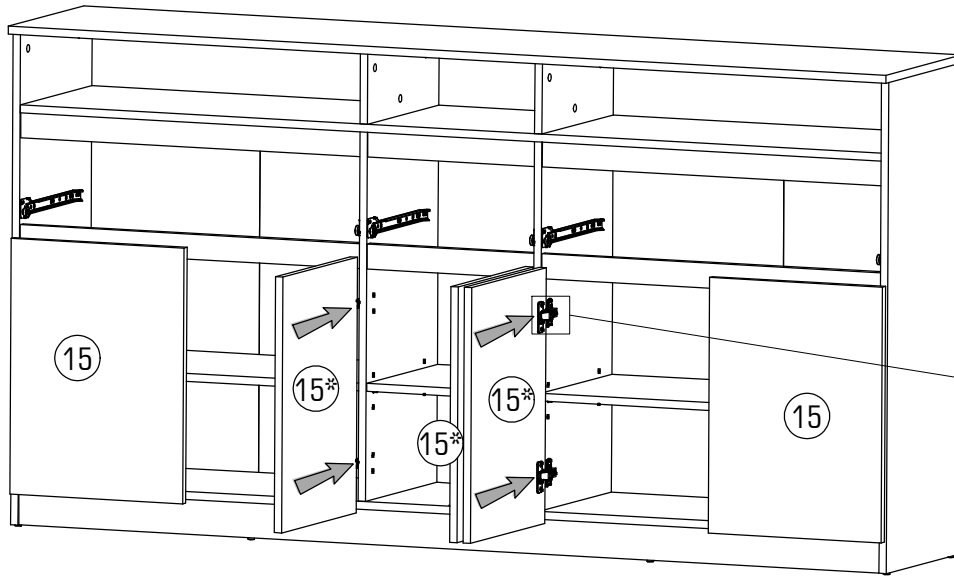
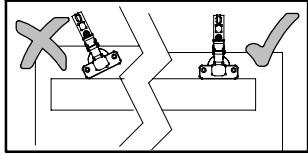
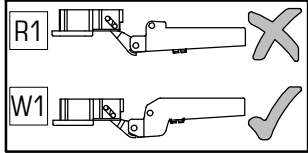
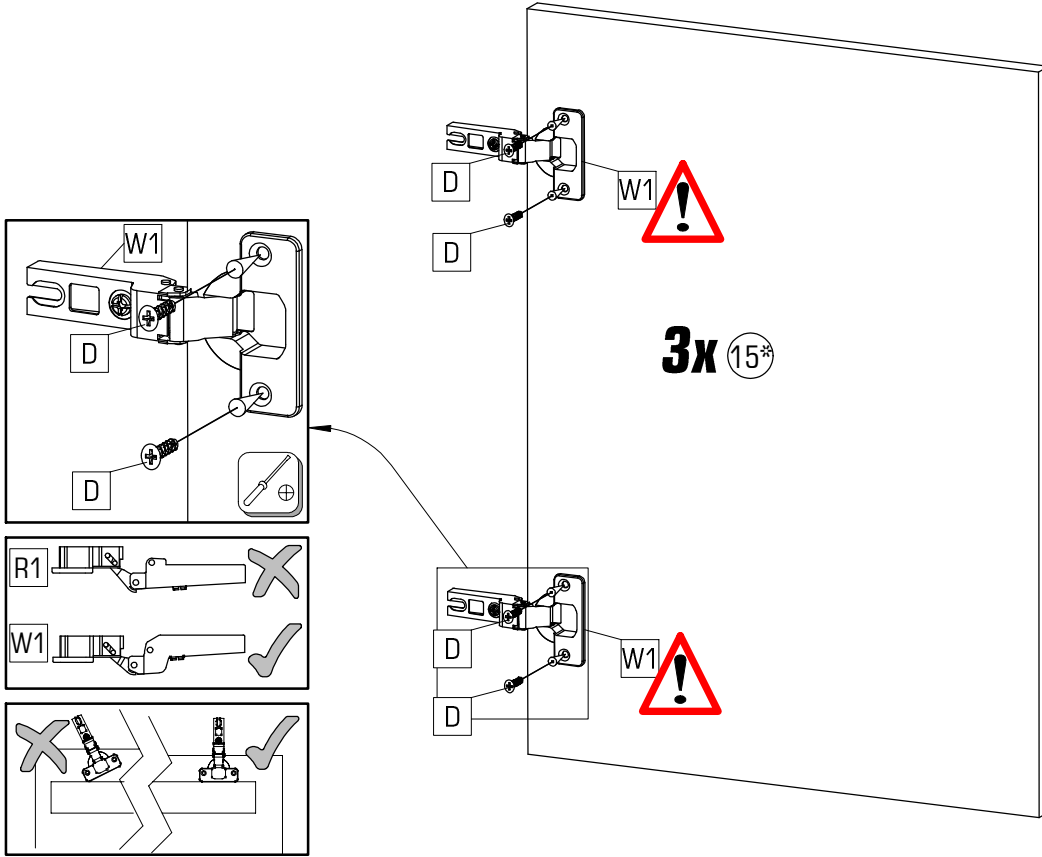

	$\varnothing 3,5 \times 15$	
D	8x	R1 4x

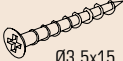

	
Ø3,5x15	
D 12x	W1 6x

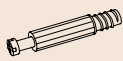

					
Ø3,5x15	Ø3,5x16	Ø7x50	Ø15x13	L=300	
D 18x	E 13x	F 12x	P1 12x	Q 12x	U2 3x

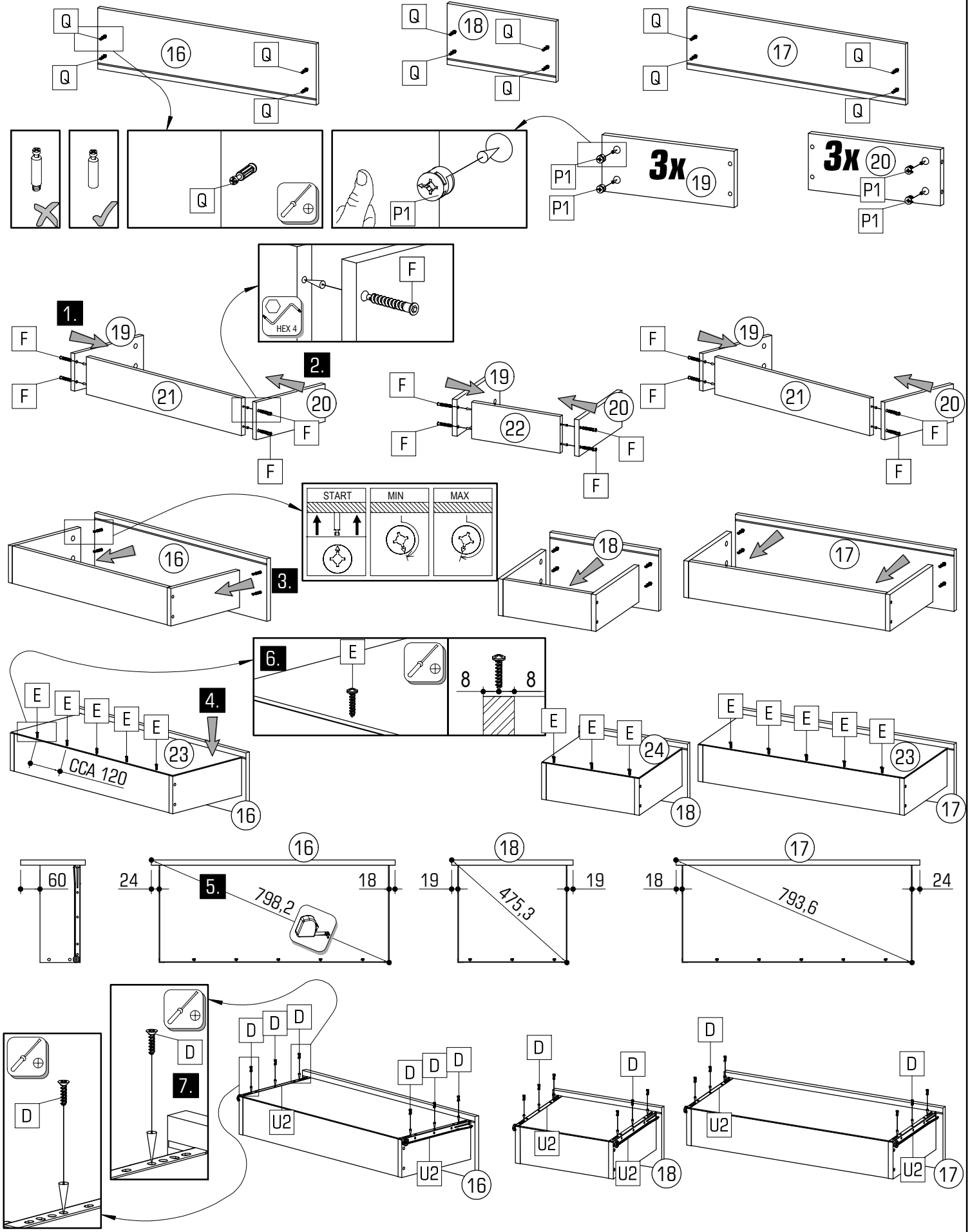

P2 12x

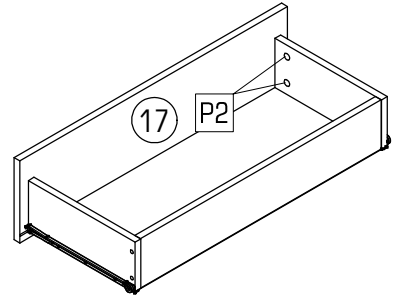
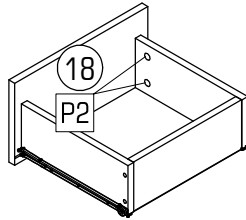
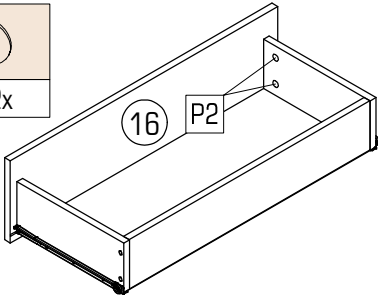

15
kg

