

20 MIN

2 X



(D) AUFBAUANLEITUNG
 (NL) HANDLEIDING VOOR DE MONTAGE
 (TR) MONTAJ TALIMATI
 (RO) INSTRUCTIUNI DE ASAMBLARE
 (F) INSTRUCTION D'ASSEMBLAGE
 (CZ) POKYNY K MONTÁŽI
 (BG) ИНСТРУКЦИИ ЗА МОНТАЖ
 (HR) UPUTSTVA ZA MONTAŽU

(GB) ASSEMBLY INSTRUCTIONS
 (PL) INSTRUKCJA MONTAŻU
 (RU) Инструкция по монтажу
 (I) PROCEDURA DI ASSEMBLAGGIO
 (SK) POKYNY K MONTÁŽI
 (HU) ÖSSZESZERELÉSI ÚTMUTATÓ
 (SLO) NAVODILA ZA MONTAŽO
 (S) MONTERINGSANVISNING
 (LT) DIEGIMO INSTRUKCIJOS
 (E) INSTRUCCIONES DE MONTAJE

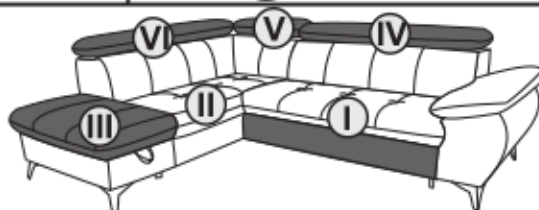
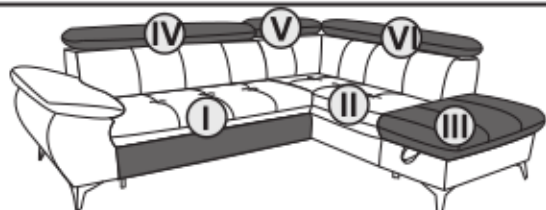

1/3

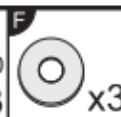
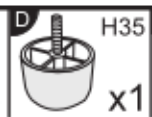
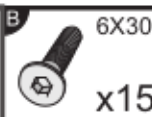
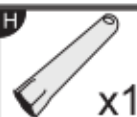
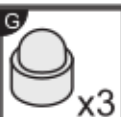

hardware bag/sachet matériel/zubehörbeutel/sachetti materiale/bolsa de materiales/worek materiałowy

pre-assembled/ pre assemble/vormontiert/premontato/wstępnie zamontowane

1

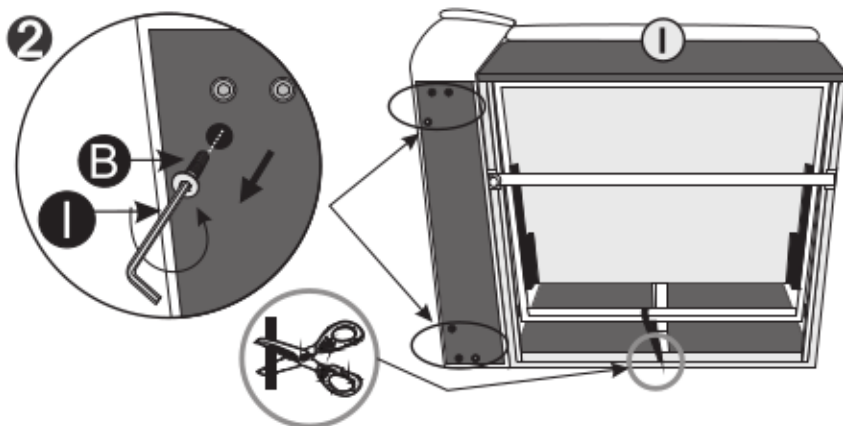
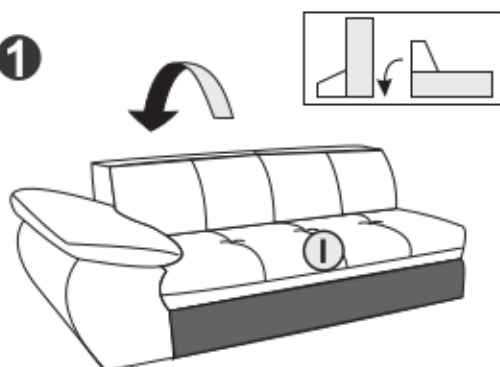

3

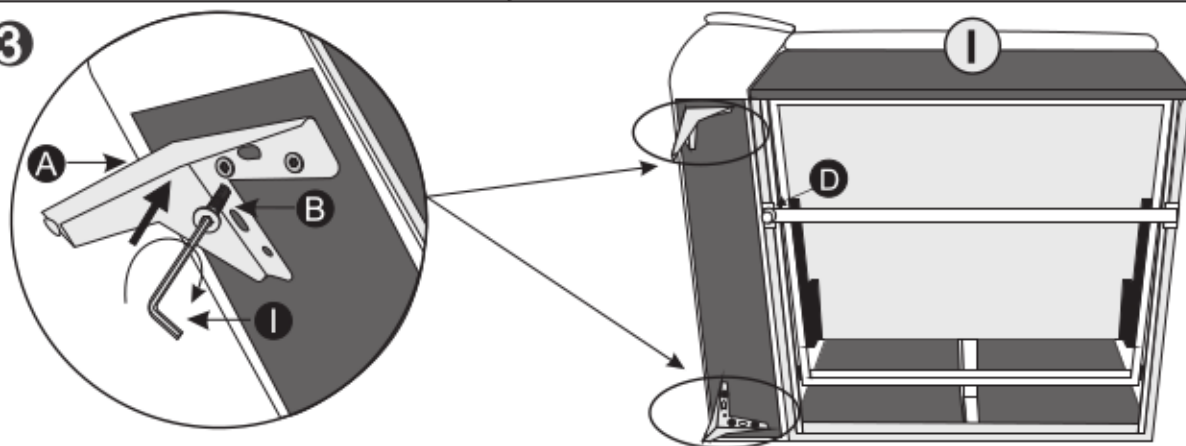

4

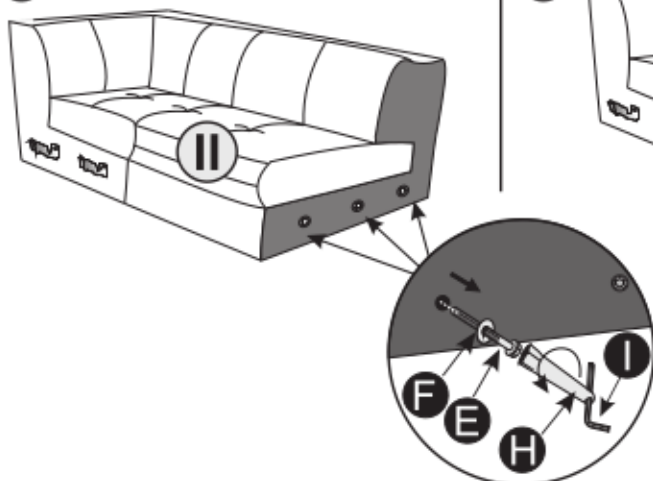

5

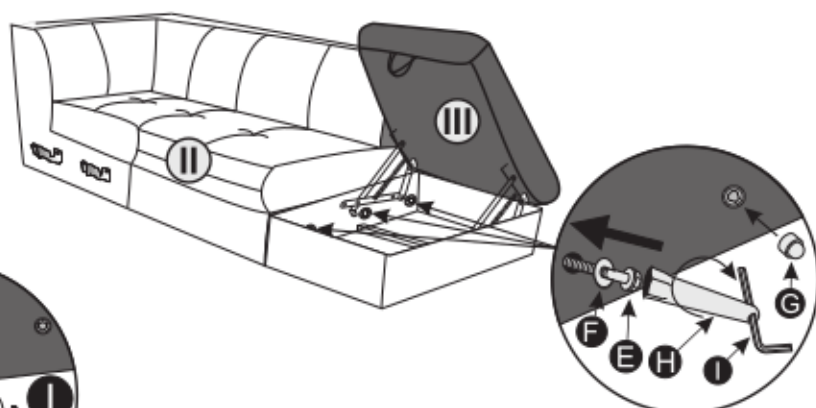
LE TRI
+ FACILEBAC
DE TRI

20 MIN

2 X



(D) AUFBAUANLEITUNG
 (NL) HANDLEIDING VOOR DE MONTAGE
 (TR) MONTAJ TALIMATI
 (RO) INSTRUCTIUNI DE ASAMBLARE
 (F) INSTRUCTION D'ASSEMBLAGE
 (CZ) POKYNY K MONTÁŽI
 (BG) ИНСТРУКЦИИ ЗА МОНТАЖ
 (HR) UPUTSTVA ZA MONTAŽU

(GB) ASSEMBLY INSTRUCTIONS
 (PL) INSTRUKCJA MONTAŻU
 (RU) ИНСТРУКЦИЯ ПО МОНТАЖУ
 (I) PROCEDURA DI ASSEMBLAGGIO
 (SK) POKYNY K MONTÁŽI
 (HU) ÖSSZESZERELÉSI ÚTMUTATÓ
 (SLO) NAVODILA ZA MONTAŽO
 (S) MONTERINGSANVISNING
 (LT) DIEGIMO INSTRUKCIJOS
 (E) INSTRUCCIONES DE MONTAJE

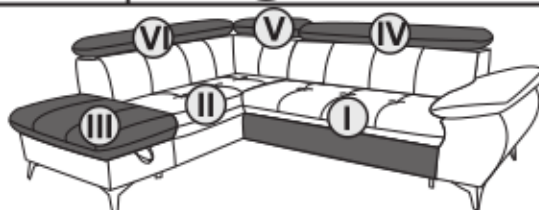
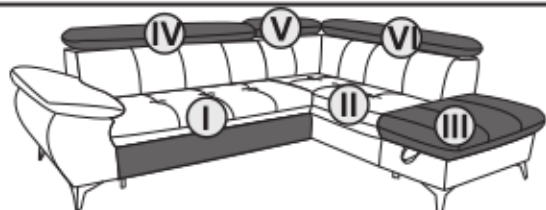

2/3

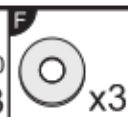
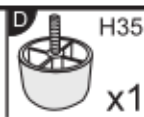
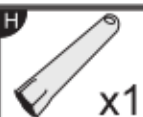
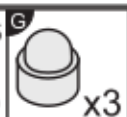

hardware bag/sachet matériel/zubehörbeutel/sachetti materiale/bolsa de materiales/worek materiałowy

pre-assembled/ pre assemble/vormontiert/premontato/wstępnie zamontowane

6

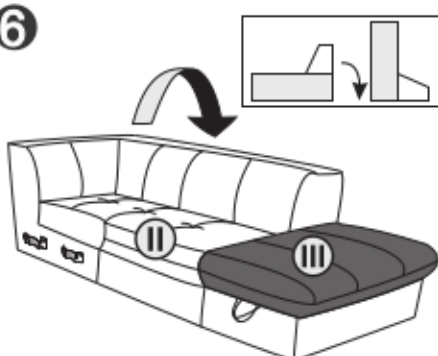

7

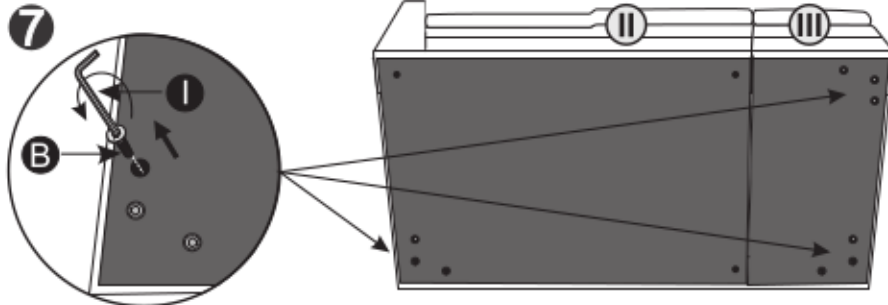

8

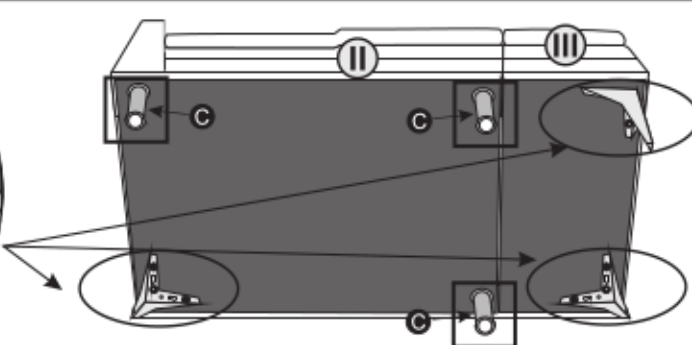
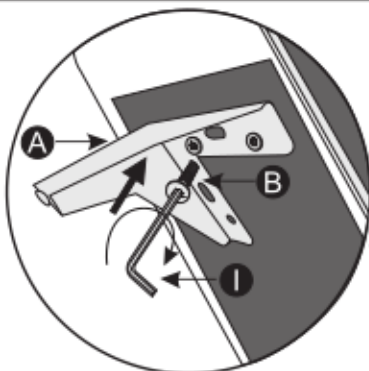

9

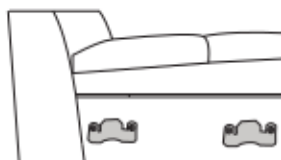
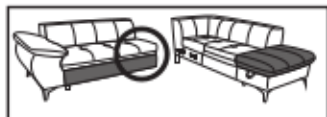
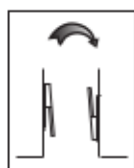
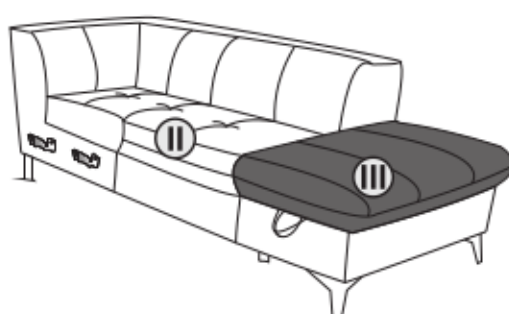
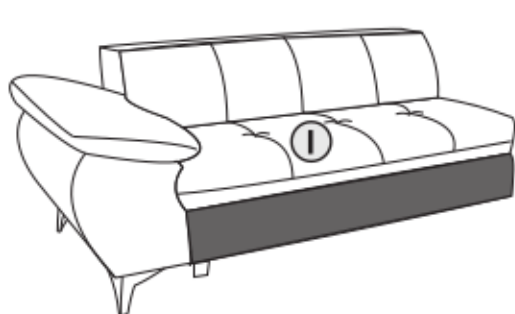
LE TRI
+ FACILEBAC
DE
TRI

20 MIN

2 X



- (D) AUFBAUANLEITUNG
- (NL) HANDLEIDING VOOR DE MONTAGE
- (TR) MONTAJ TALIMATI
- (RO) INSTRUCIUNI DE ASAMBLARE
- (F) INSTRUCTION D'ASSEMBLAGE
- (CZ) POKYNY K MONTÁŽI
- (BG) ИНСТРУКЦИИ ЗА МОНТАЖ
- (HR) UPUTSTVA ZA MONTAŽU

- (GB) ASSEMBLY INSTRUCTIONS
- (PL) INSTRUKCJA MONTAŻU
- (RU) Инструкция по монтажу
- (I) PROCEDURA DI ASSEMBLAGGIO
- (SK) POKYNY K MONTÁŽI
- (HU) ÖSSZESZERELÉSI ÚTMUTATÓ
- (SLO) NAVODILA ZA MONTAŽO
- (S) MONTERINGSANVISNING
- (LT) DIEGIMO INSTRUKCIJOS
- (E) INSTRUCCIONES DE MONTAJE

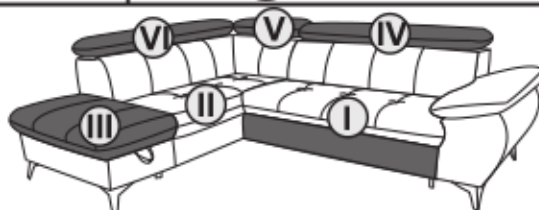
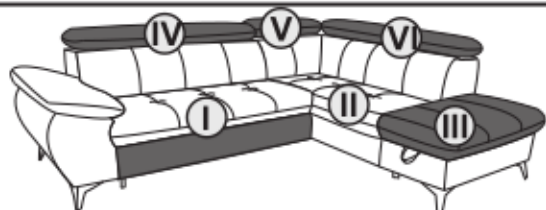

3/3

10

1/3

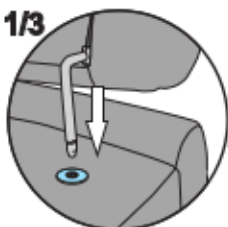

2/3



3/3

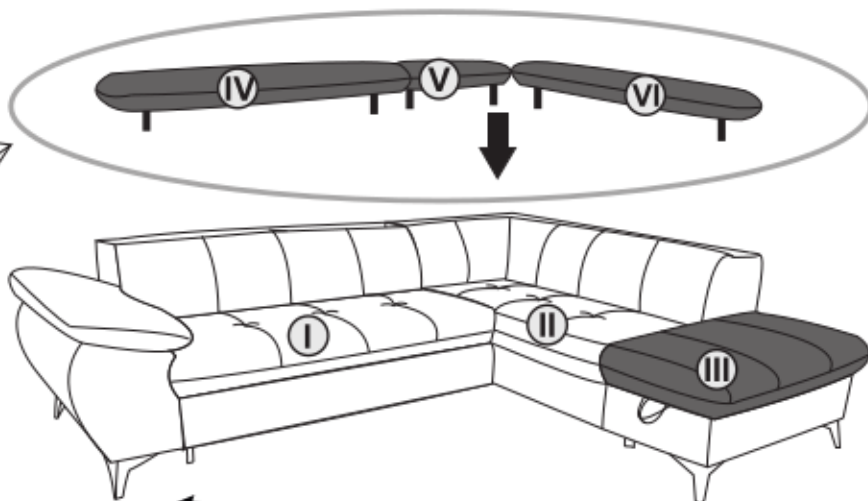
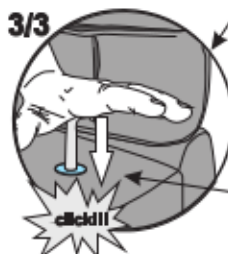

11

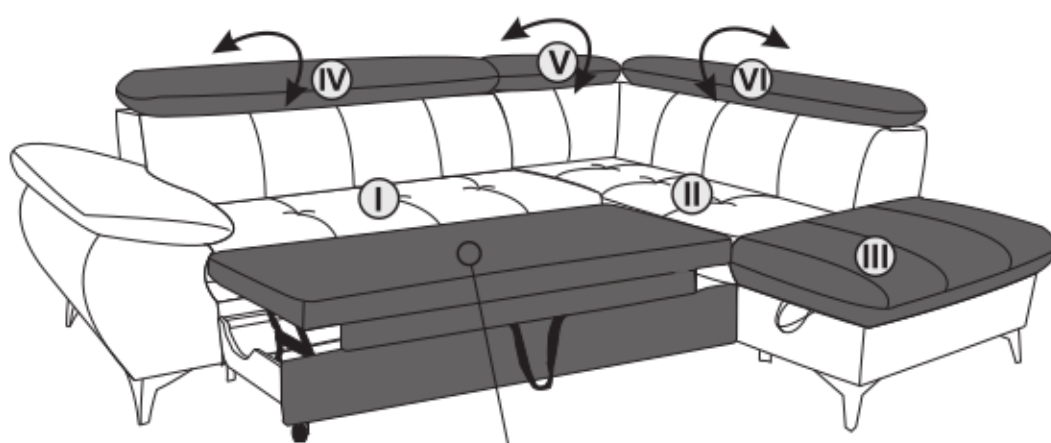

1/4

2/4

3/4

4/4

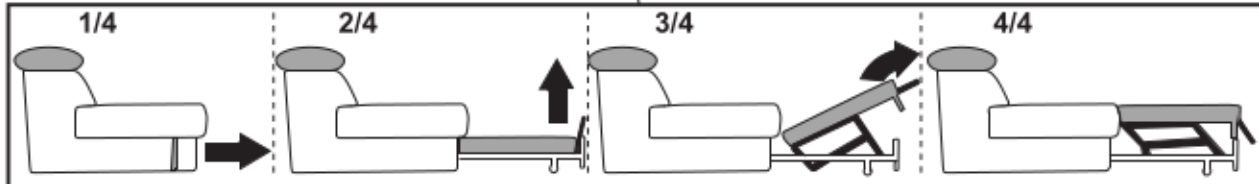

LE TRI + FACILE



BAC DE TRI

20 MIN

2 X



- (D) AUFBAUANLEITUNG
- (NL) HANDLEIDING VOOR DE MONTAGE
- (TR) MONTAJ TALIMATI
- (RO) INSTRUCIUNI DE ASAMBLARE
- (F) INSTRUCTION D'ASSEMBLAGE
- (CZ) POKYNY K MONTÁŽI
- (BG) ИНСТРУКЦИИ ЗА МОНТАЖ
- (HR) UPUTSTVA ZA MONTAŽU

- (GB) ASSEMBLY INSTRUCTIONS
- (PL) INSTRUKCJA MONTAŻU
- (RU) Инструкция по монтажу
- (I) PROCEDURA DI ASSEMBLAGGIO
- (SK) POKYNY K MONTÁŽI
- (HU) ÖSSZESZERELÉSI ÚTMUTATÓ
- (SLO) NAVODILA ZA MONTAŽO
- (S) MONTERINGSANVISNING
- (LT) DIEGIMO INSTRUKCIJOS
- (E) INSTRUCCIONES DE MONTAJE



0
10
20
30
40
50
60
70
80
90
100
110
120
130
140
150
160
170
180

Le produit destiné à un usage domestique.

Après assemblage de ce produit, il est conseillé d'aé régulièrement la pièce pendant quelques jours.
Risque de pincement lors de la fermeture du coffre.

The product is intended for domestic use.

After assembling this product, it is advisable to ventilate the room regularly for a few days.
Risk of being pinched when closing the box.



LE TRI
+ FACILE

