

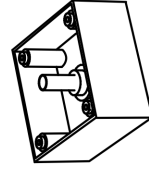

d1 = d2

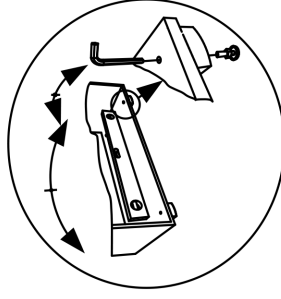

F1

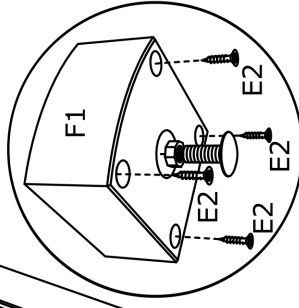
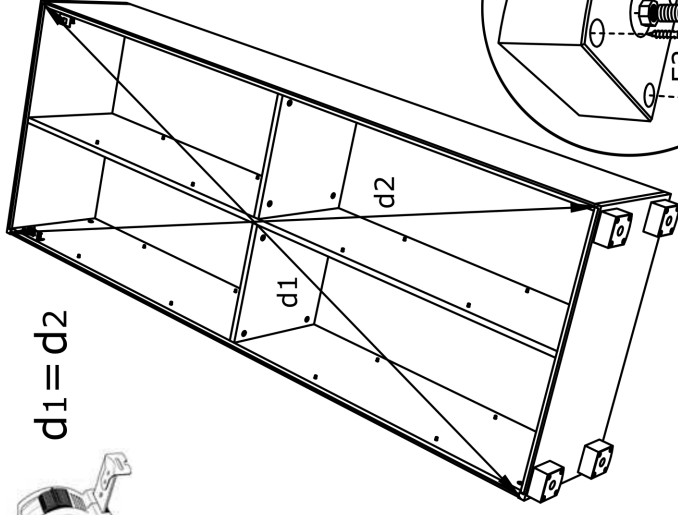
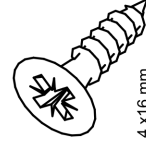

E2

4 x 16 mm

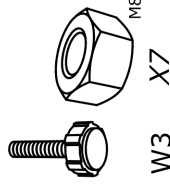

W3

M8

X7

1

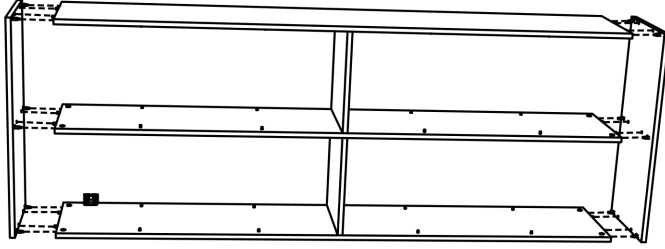

2

3D



5

4

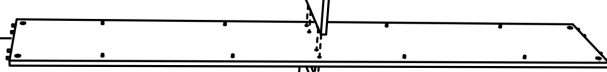

5

3L

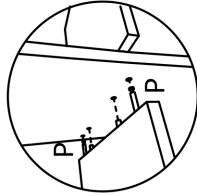
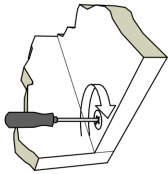

P

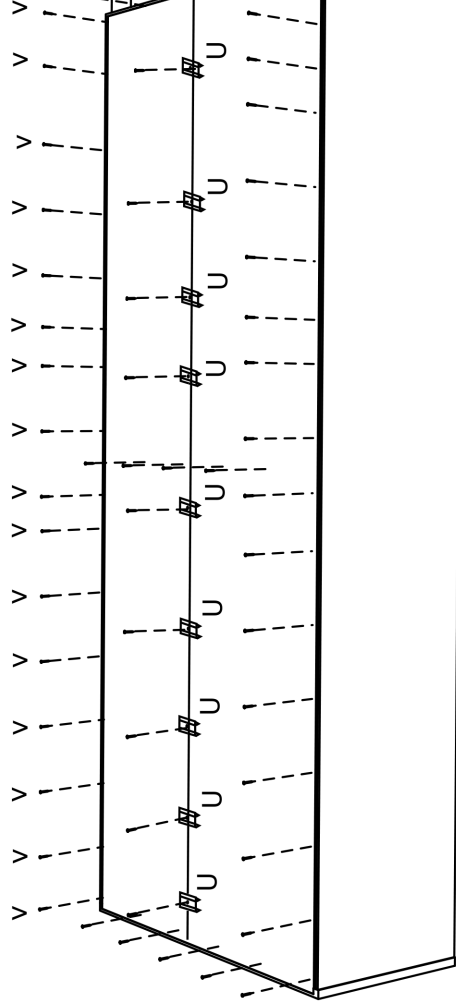

U



P



V

