

SLIM

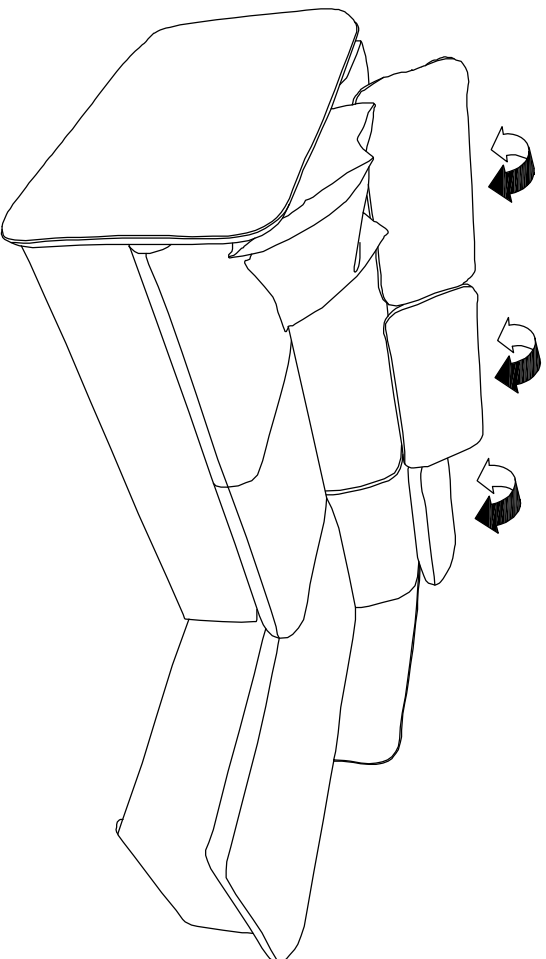

- (D) Montageanleitung
- (FR) Notice de montage
- (NL) Handleiding voor de montage
- (CZ) Montážní návod
- (HU) Szerelési útmutató
- (TR) Montaj talimatı
- (GB) Assembly Instructions
- (IT) Istruzioni di montaggio
- (PL) Instrukcja montażu
- (SK) Návod na montáž
- (RO) Instrucțiuni de montaj
- (RU) Инструкции по монтажу

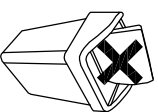
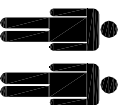
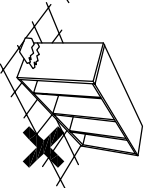
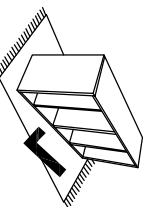

5 m h

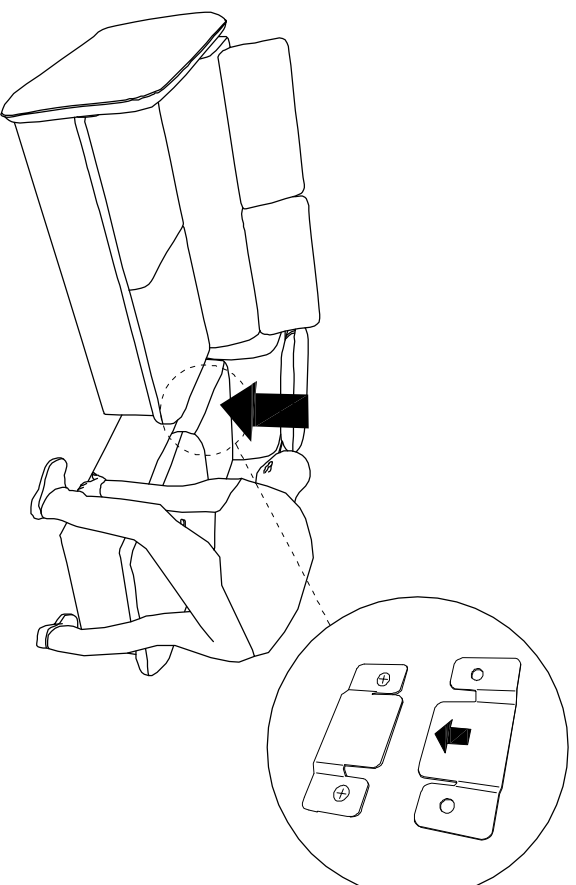

1

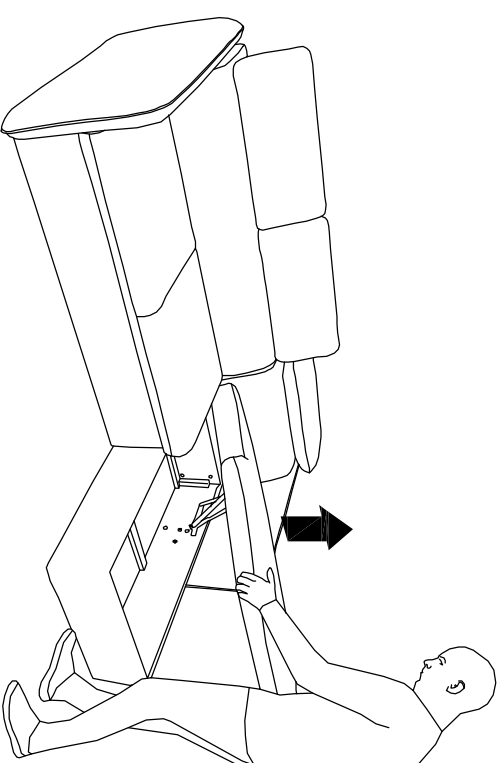

2

