















<b>K6</b>  1x	<b>H23</b>  H30-350mm 2x	<b>G22</b>  3x16 26x	<b>B1</b>  Ø8x30 36x	<b>W10</b> 
<b>W2</b>  1x	<b>A1</b>  Ø7x50 13x	<b>W4</b>  Ø1,4x20 14x	<b>I7</b>  Ø18 14x	
<b>K1</b>  Ø15x12 32x	<b>K5</b>  30x	<b>P4</b>  4x		

1

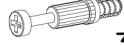

B1

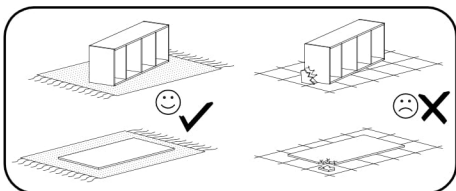
Ø8x30

14x

K1

Ø15x12

22x

K5

18x

K5

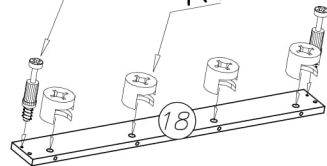
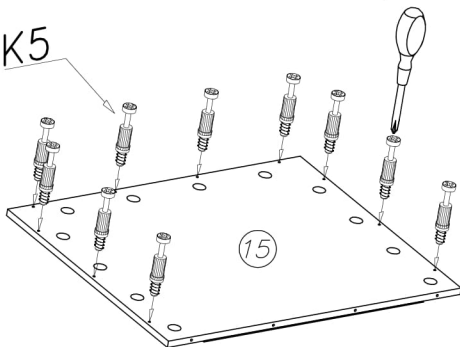

15

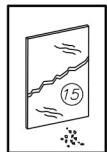

15

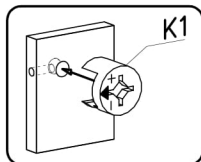

K1

K1

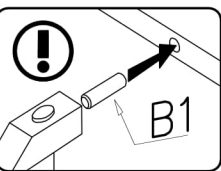

B1

K5

B1

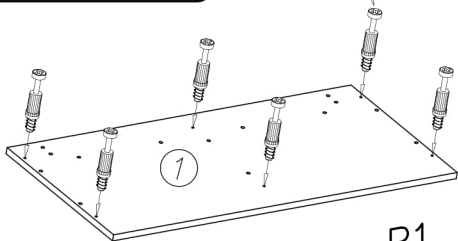

7

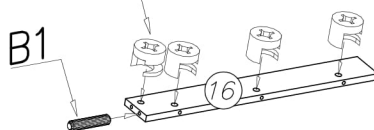

16

K1

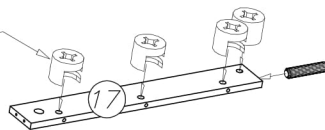

17

K1

B1

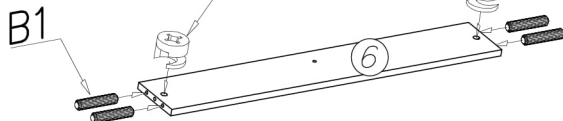

6

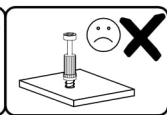
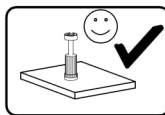

K1

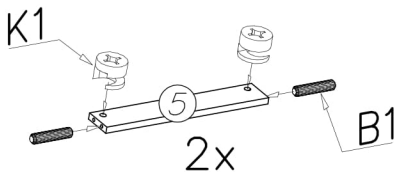

2x

K1

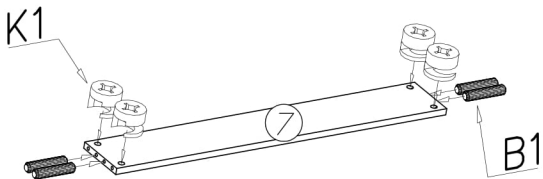

7

A

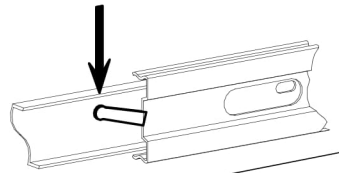
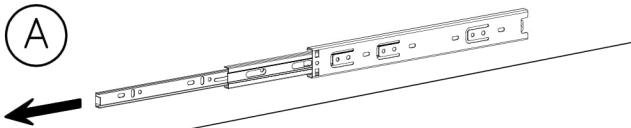

B

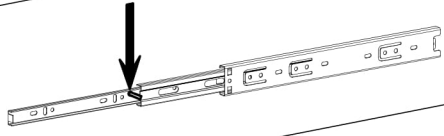

C

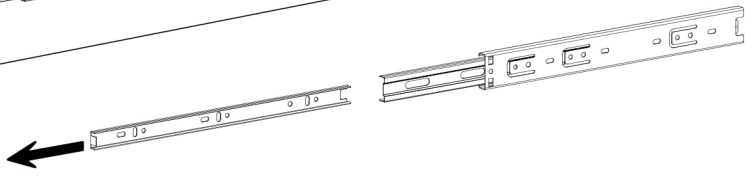

2

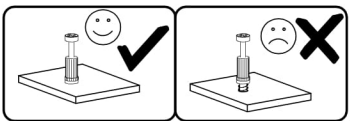

H23	K1		4x
	Ø15x12		4x
H30-350mm	1x	3x16	4x
B1		K5	8x
Ø8x30	4x	P4	4x
			4x

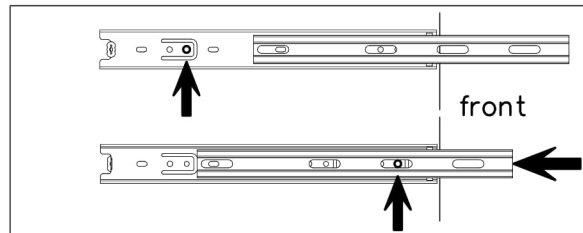
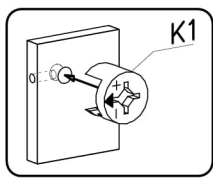
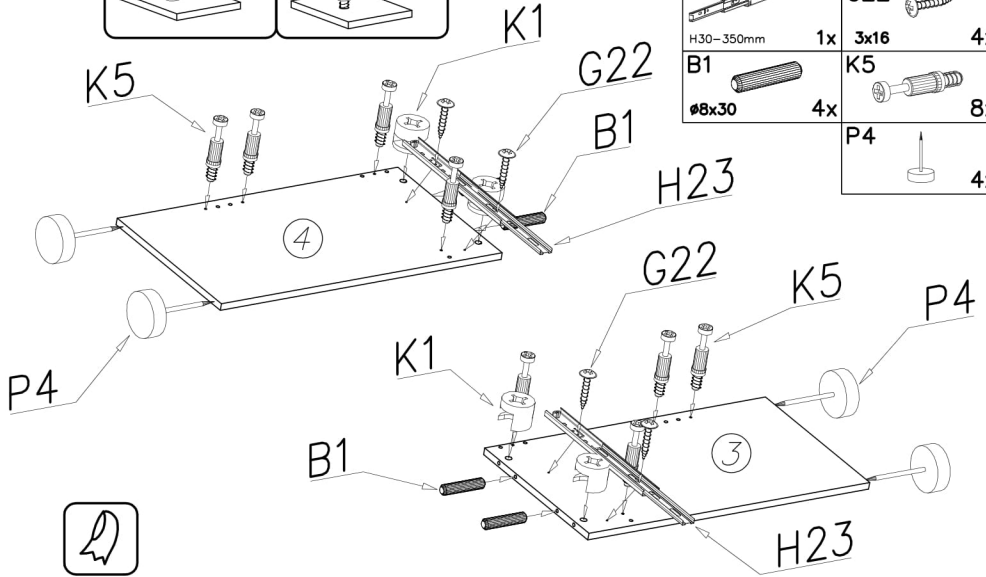

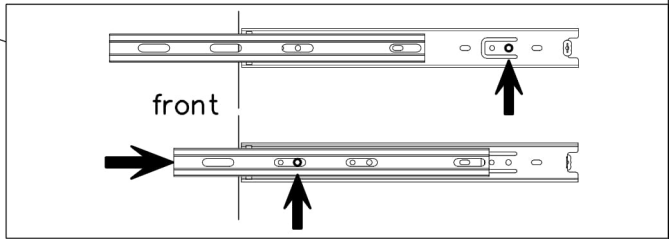
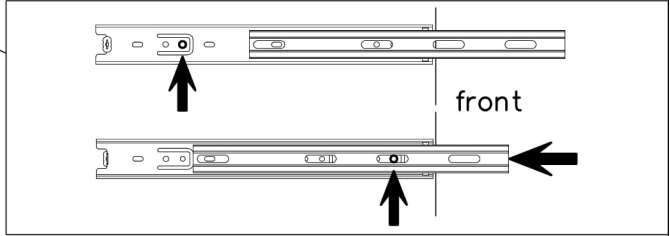
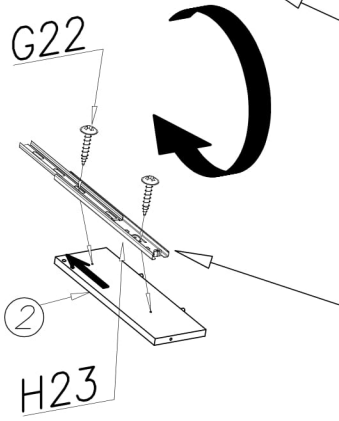
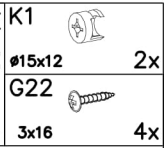
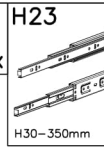
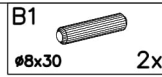
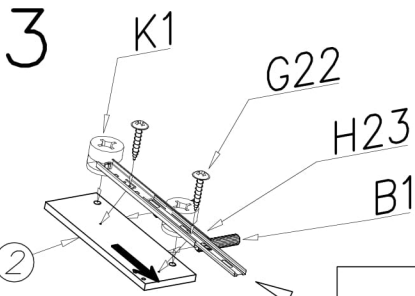

# 4

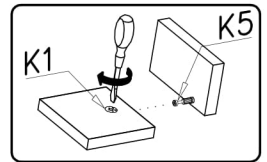
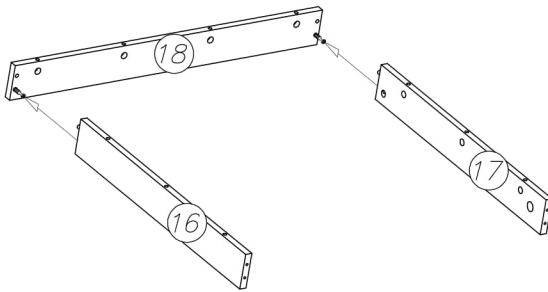

5

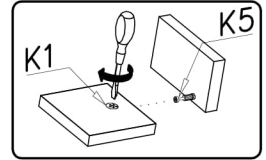
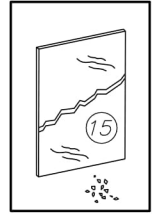
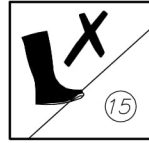
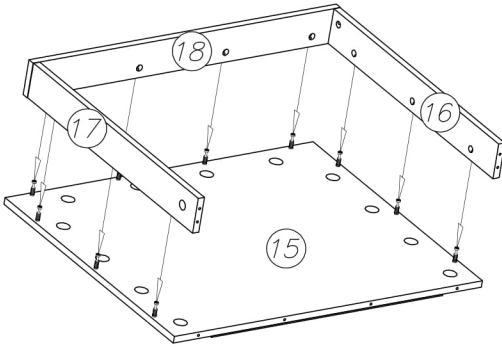

6

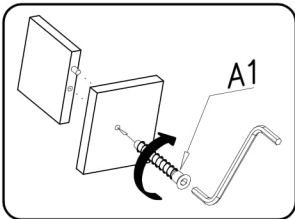
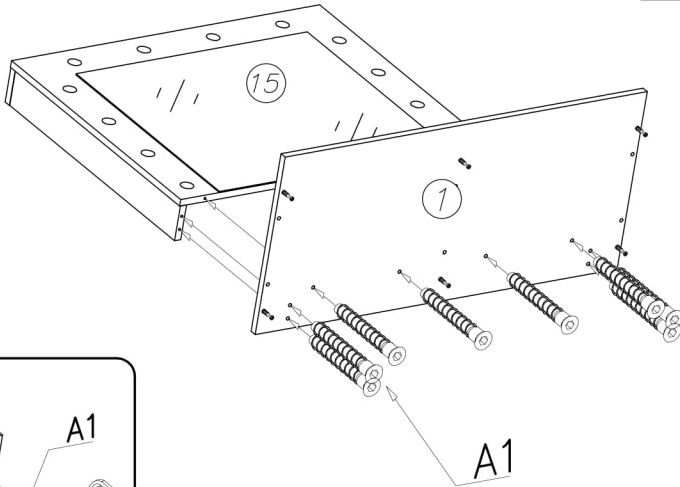
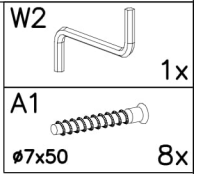

7

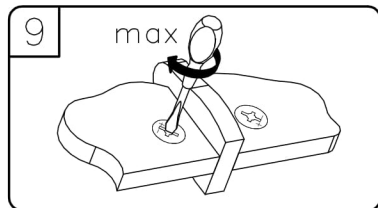
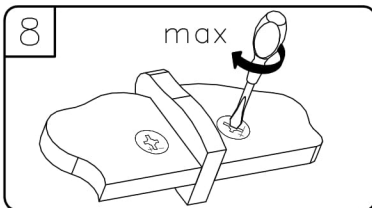
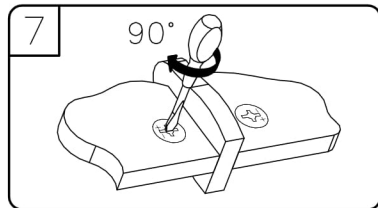
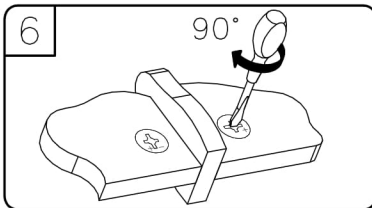
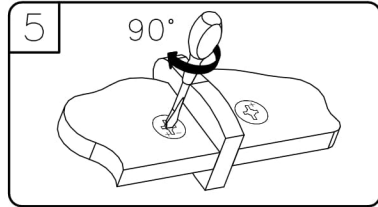
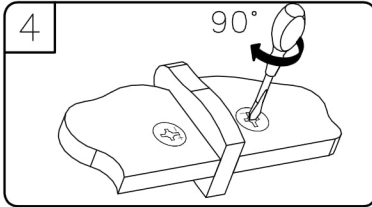
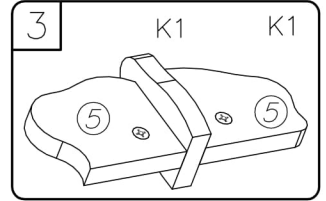
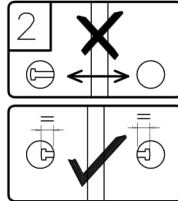
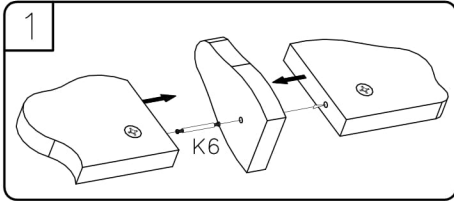
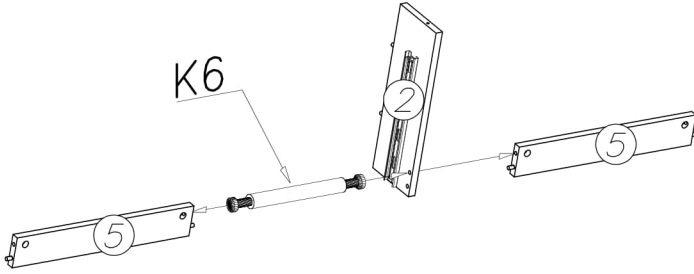

8

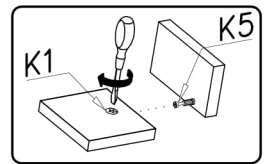
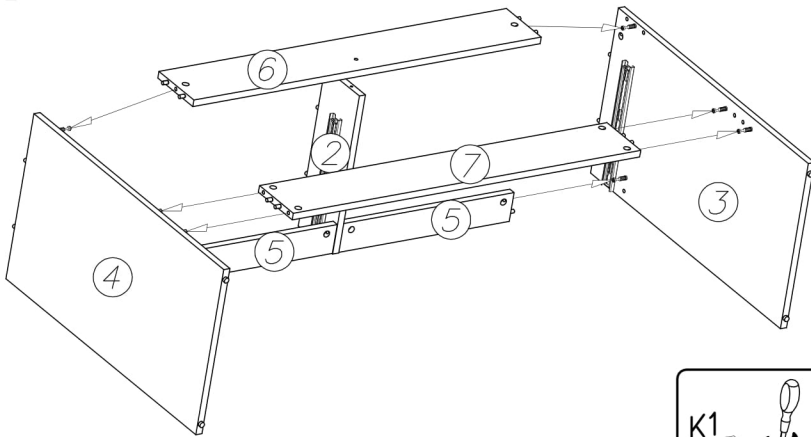

9

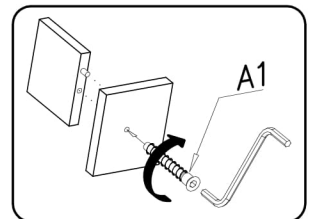
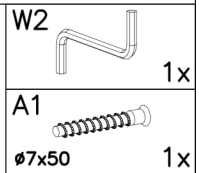
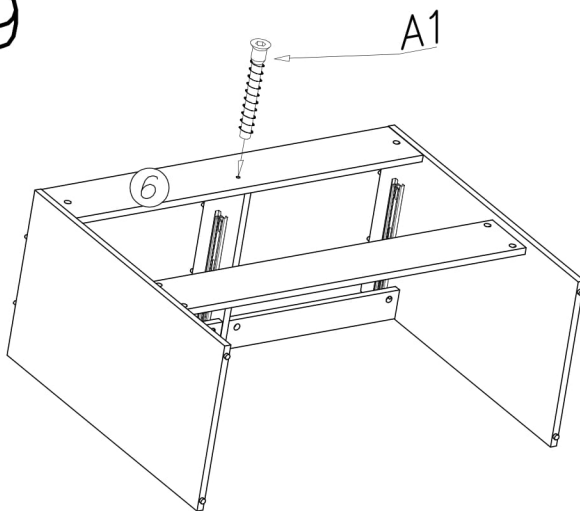

# 10

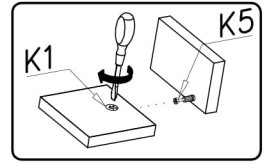
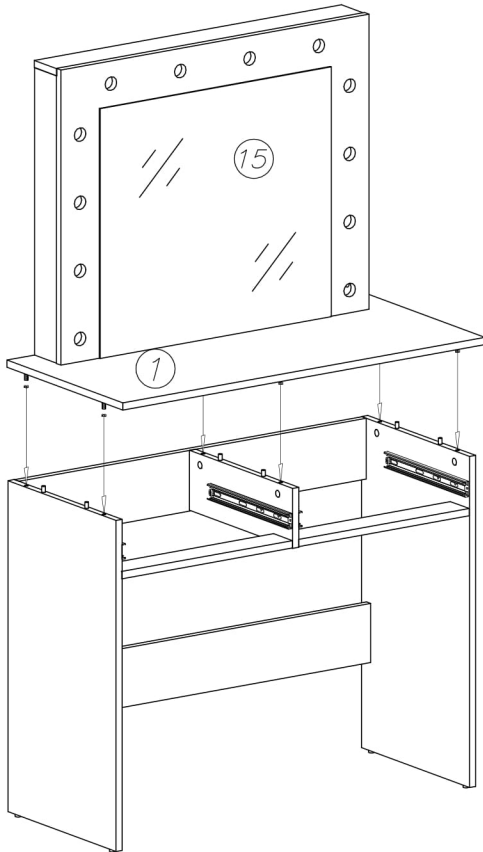

# 11

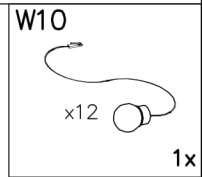
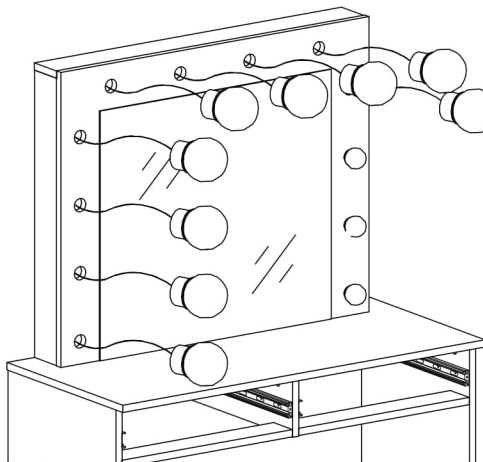



# 12

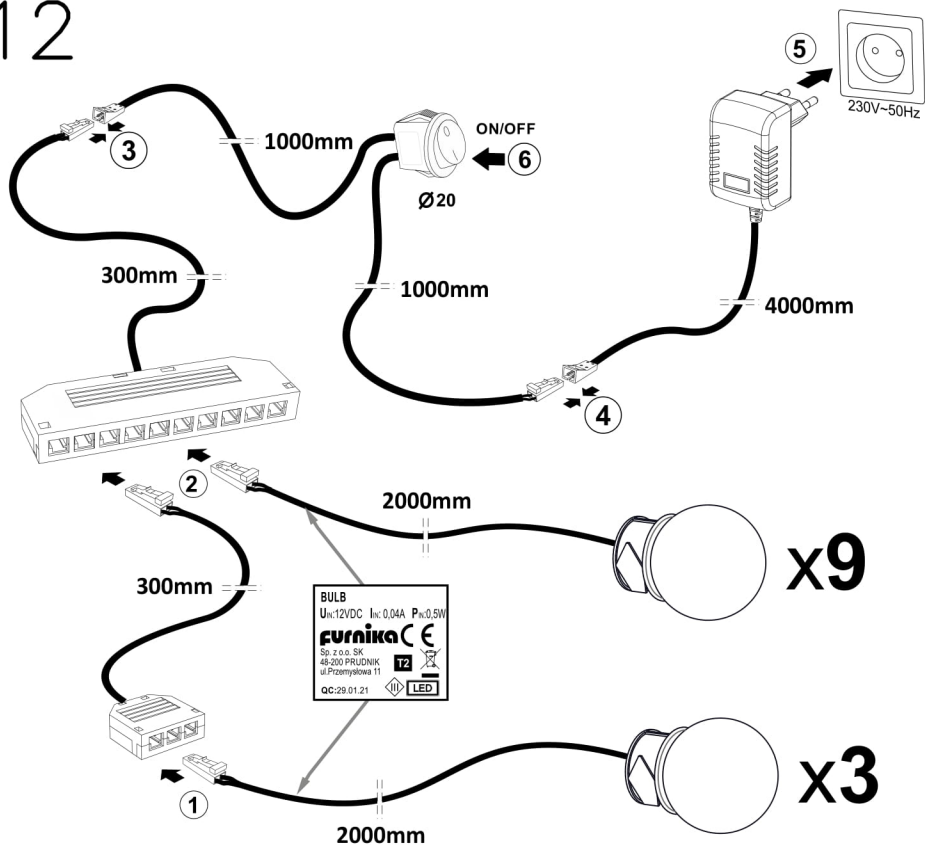

# 13

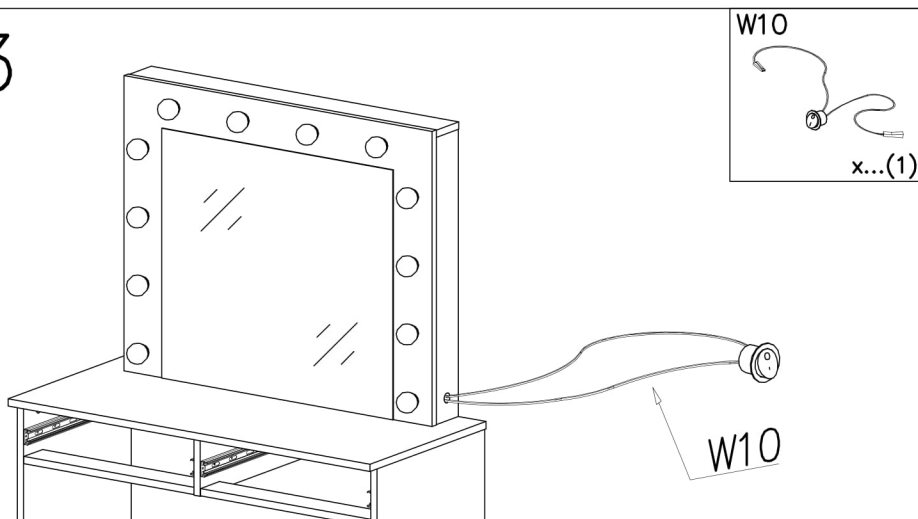

# 14

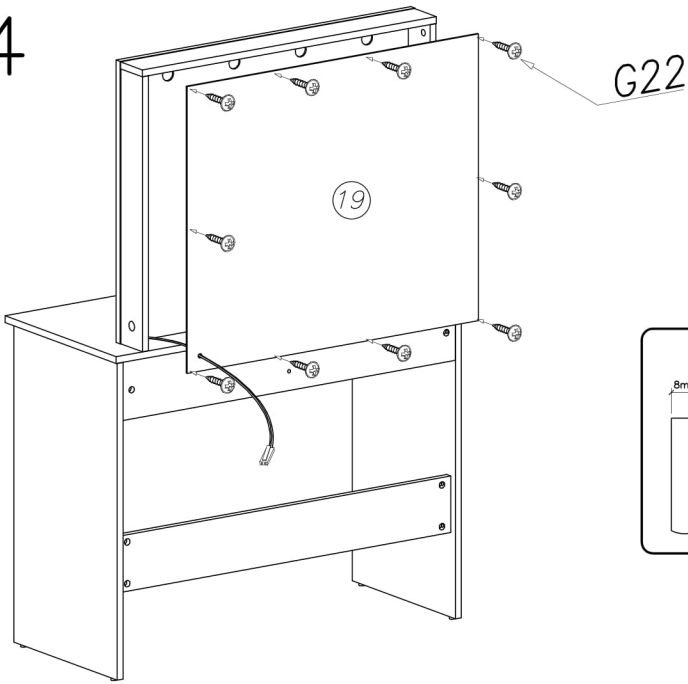

G22  
3x16 10x

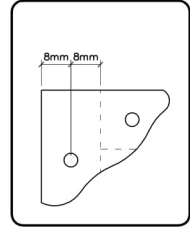

# 15

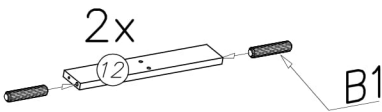

K1  
ø15x12 4x

B1  
ø8x30 16x

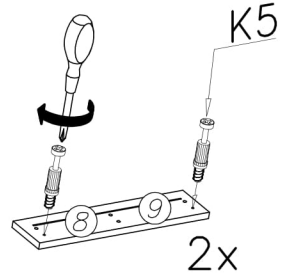
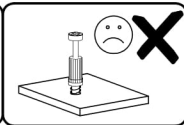
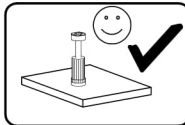
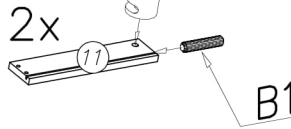
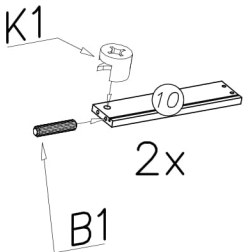
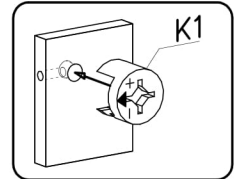
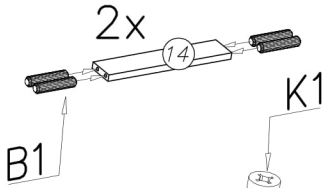
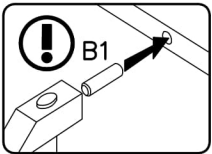

2x

10/13

# 16

2x

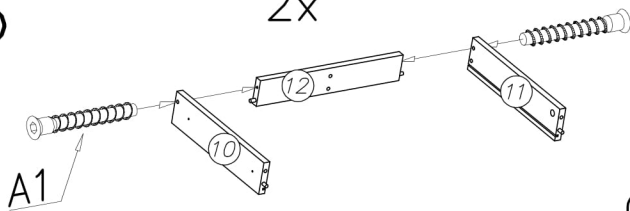

- W2 1x
- A1  $\varnothing 7 \times 50$  4x

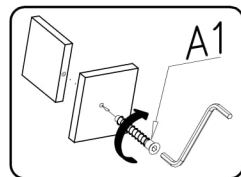
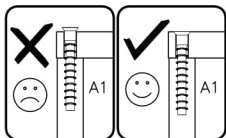

# 17

2x

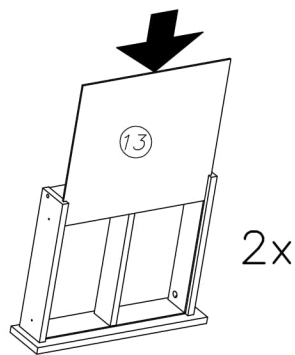
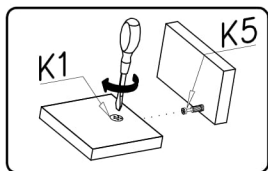
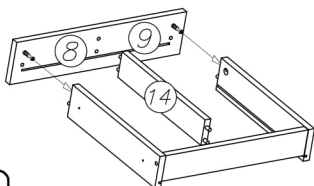

# 18

a=b



- W4  $\varnothing 1,4 \times 20$  8x

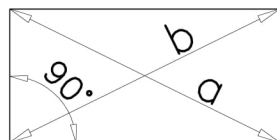
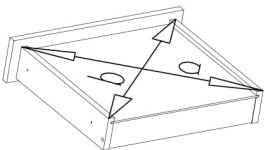

2x

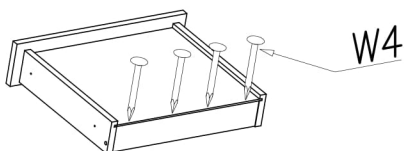

# 19

W4  
Ø1,4x20 6x

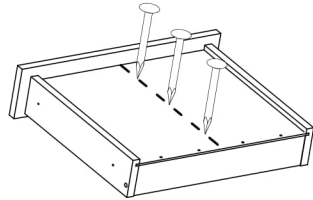
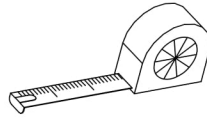
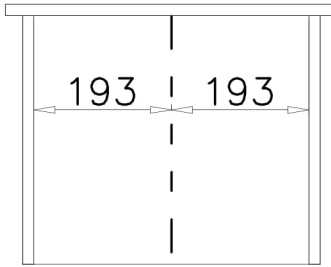

2x

# 20

G22  
3x16 8x

H23  
H30-350mm 2x

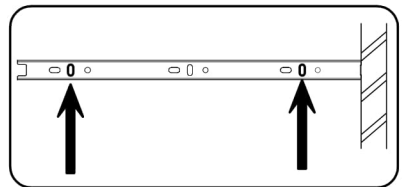
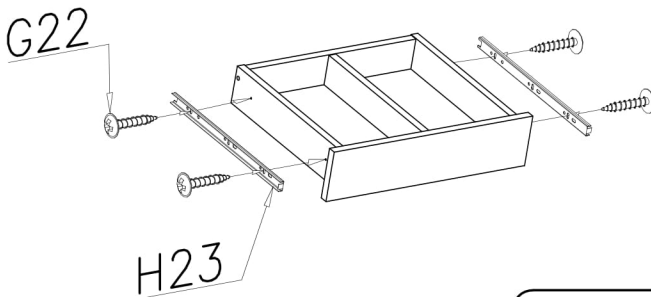

# 21

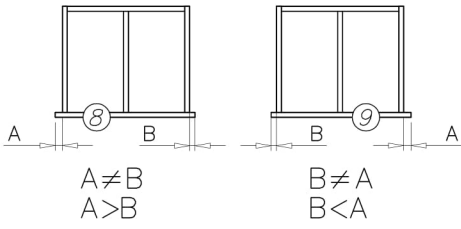

17

Ø18



14x

