

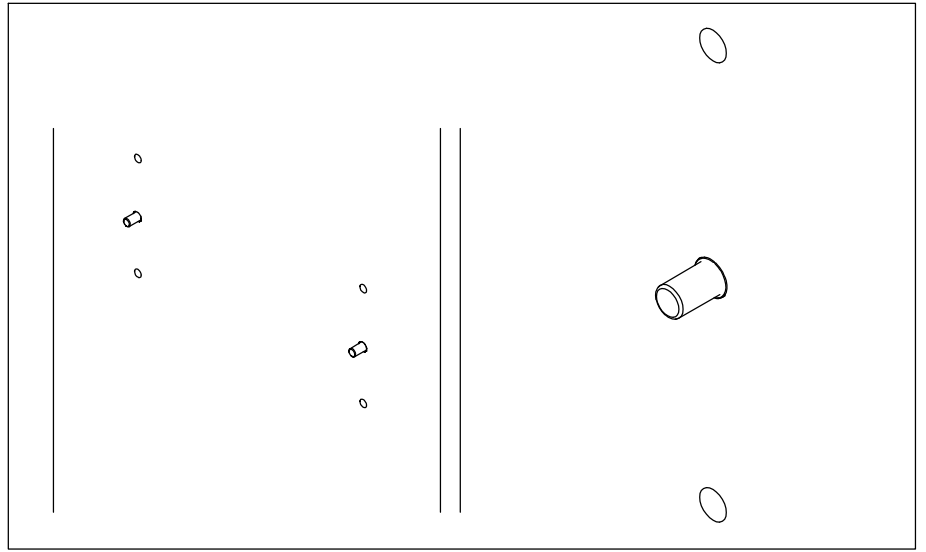

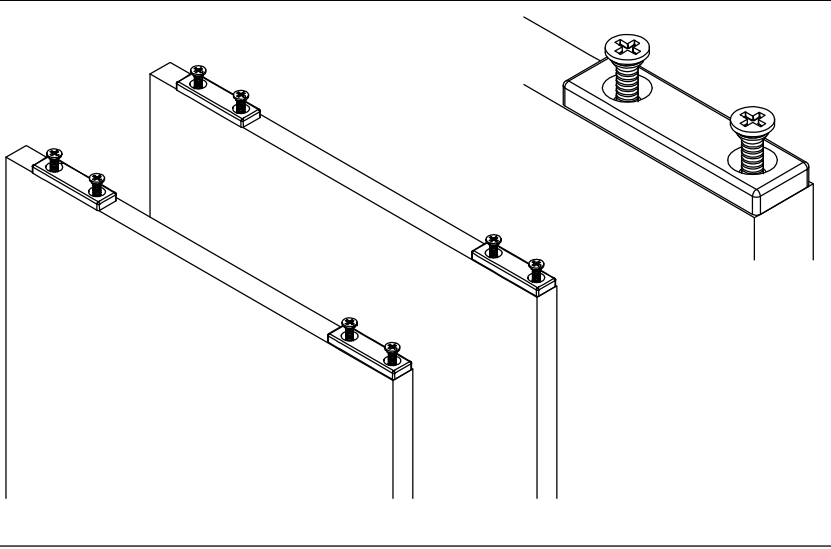

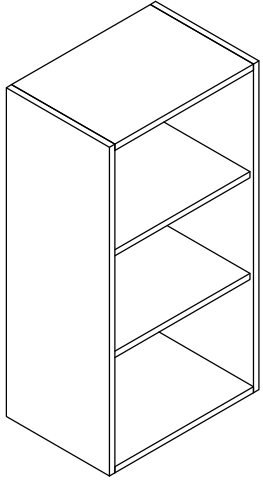

LA- 11

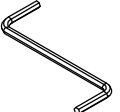

-  8x
-  1x
-  8x
-  8x
-  3x16 4x
-  25x

