

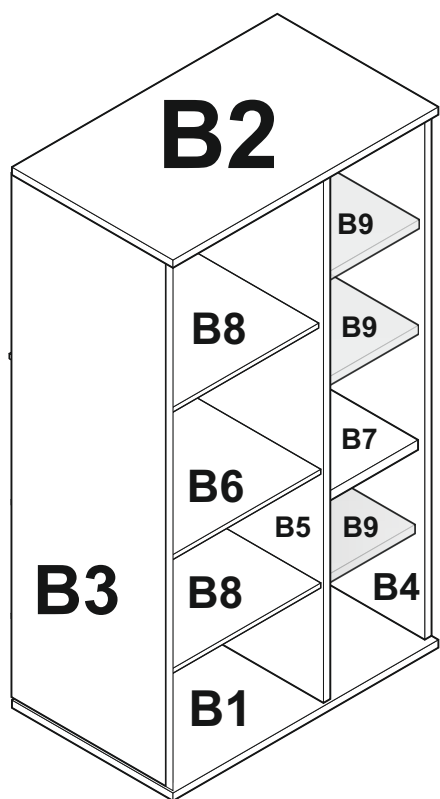

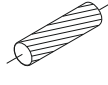

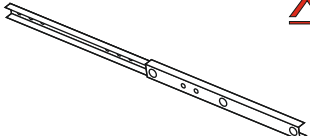





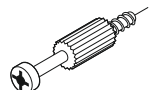

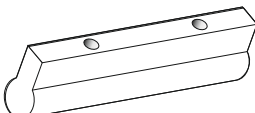

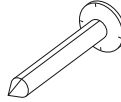
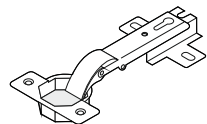
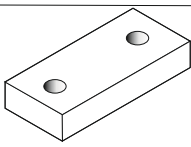

LAUREN SV

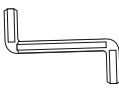

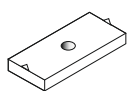
1	 8x35	<u>X 24</u>	23	 7x50	<u>X 2</u>	9A	 X 8
2	 3.5X30	<u>X 10</u>	36	 X 12	39	22A	 X 16
3	 X 4	13	13	 X 8	12	39	 3x20 X 20
4	 3.5X30	<u>X 8</u>	9	 X 8	25	12	 X 80
5	 X 7	10	10	 X 4	4a	25	 M 4 X 8 X 2
6	 5x11	<u>X 26</u>	26	 X 1	14	24	 X 2
35	 X 20	22	22	 7x50 X 16	30	4a	 4x16 X 12
						14	 X 12
						30	 LED LIGHTS X 1



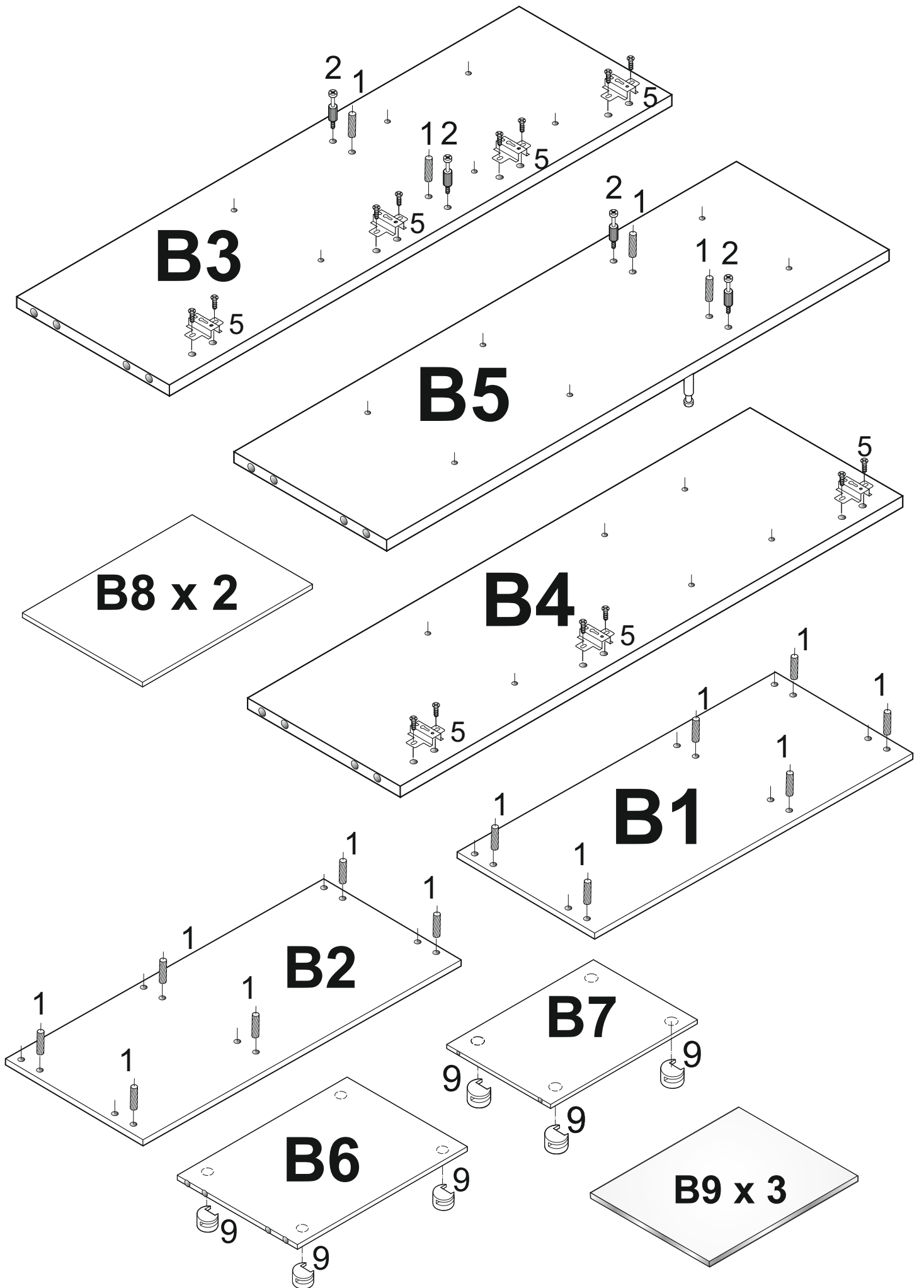
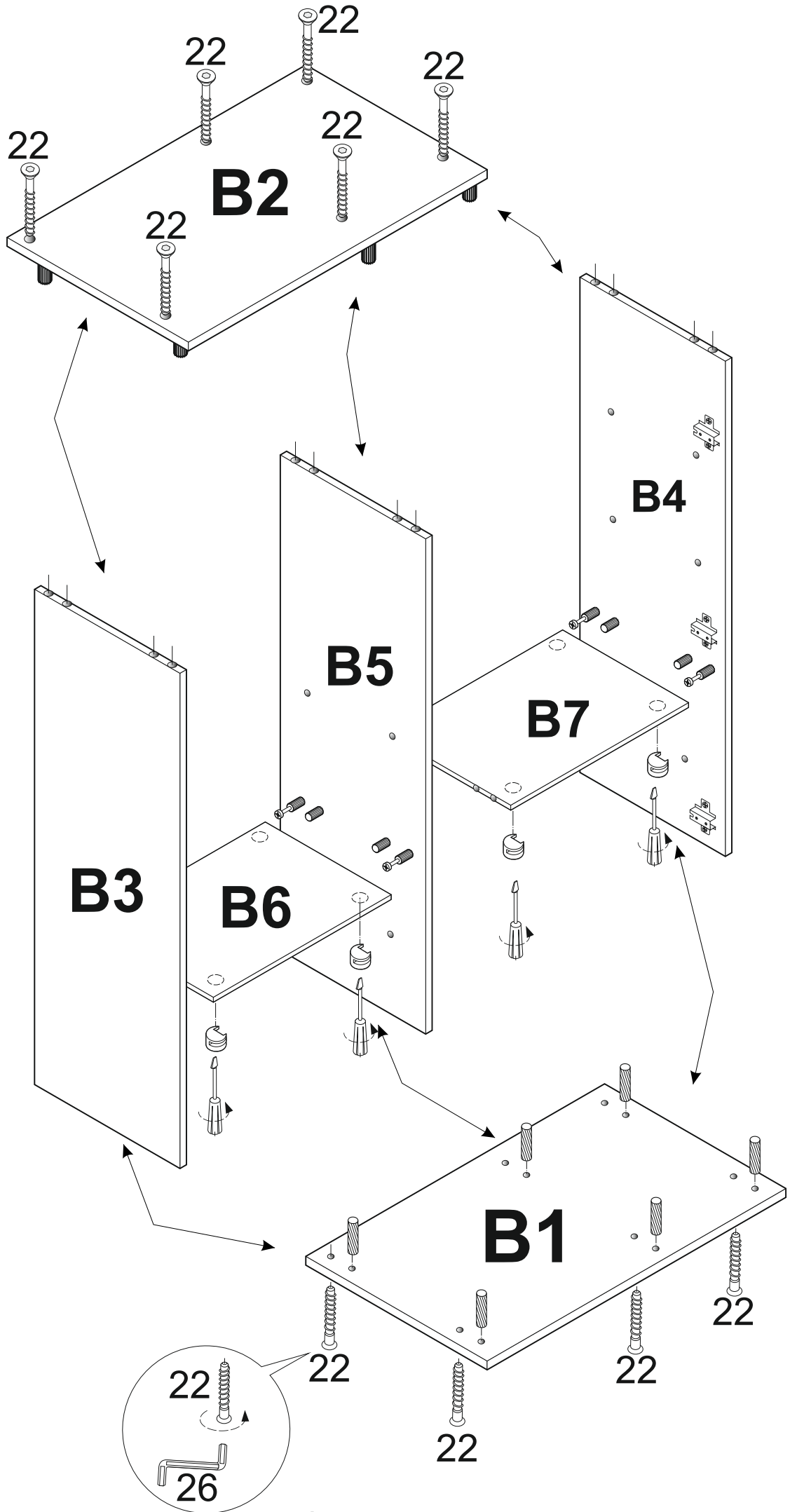

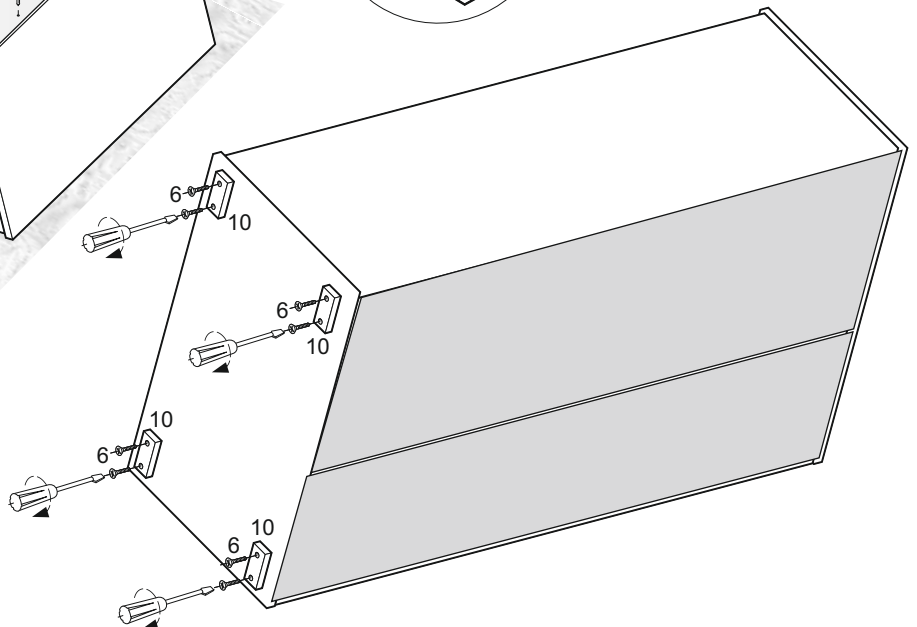
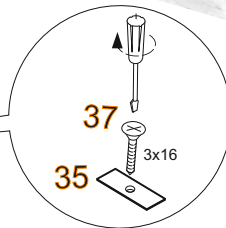
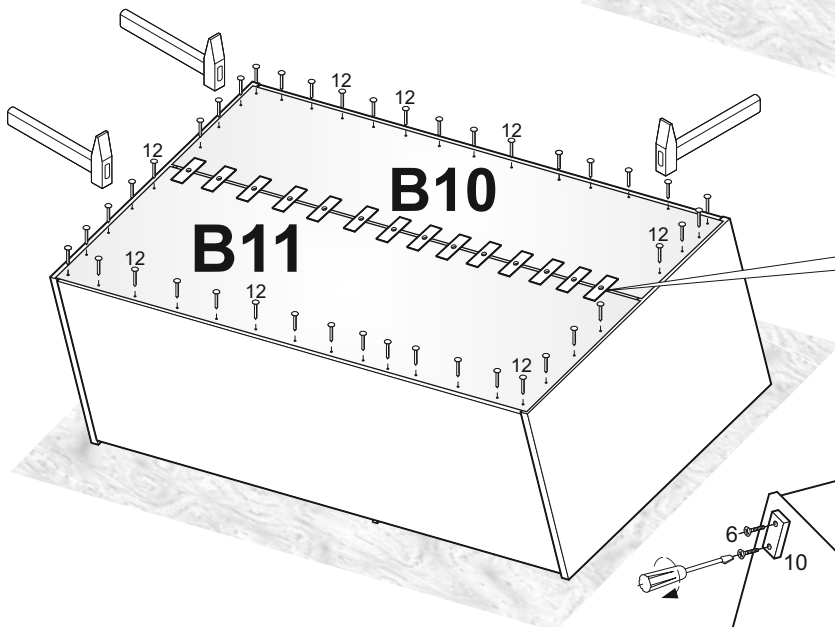
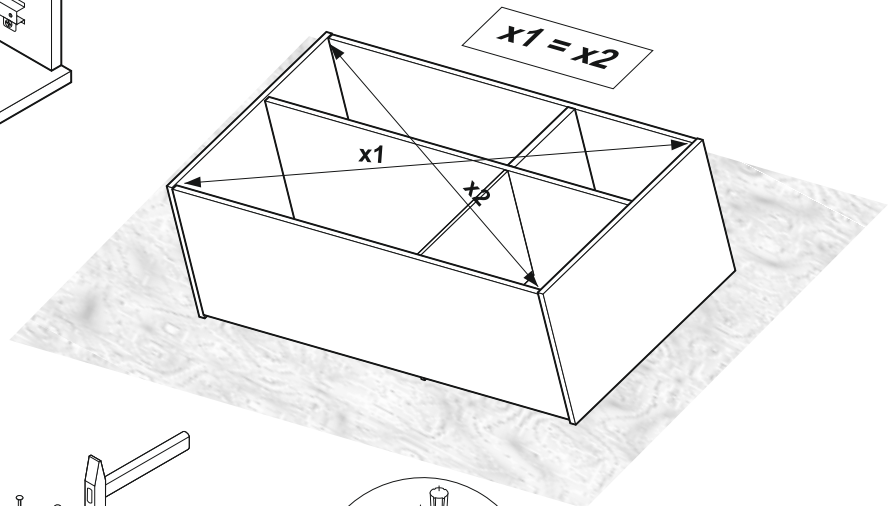
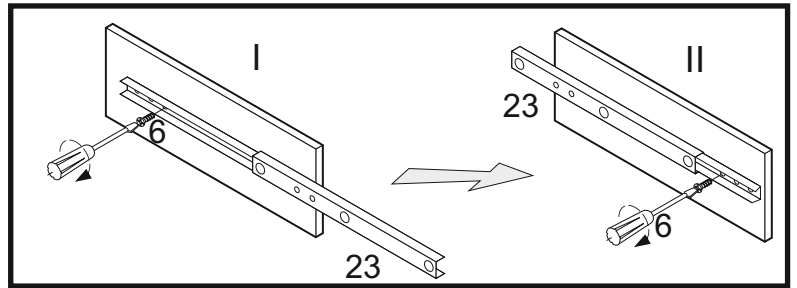
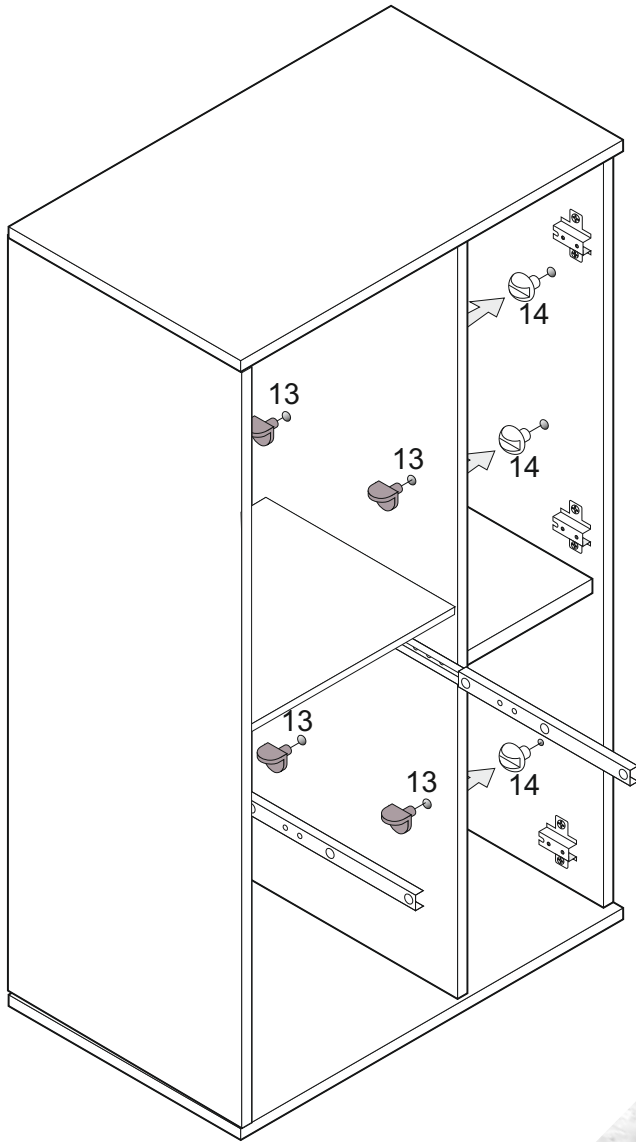

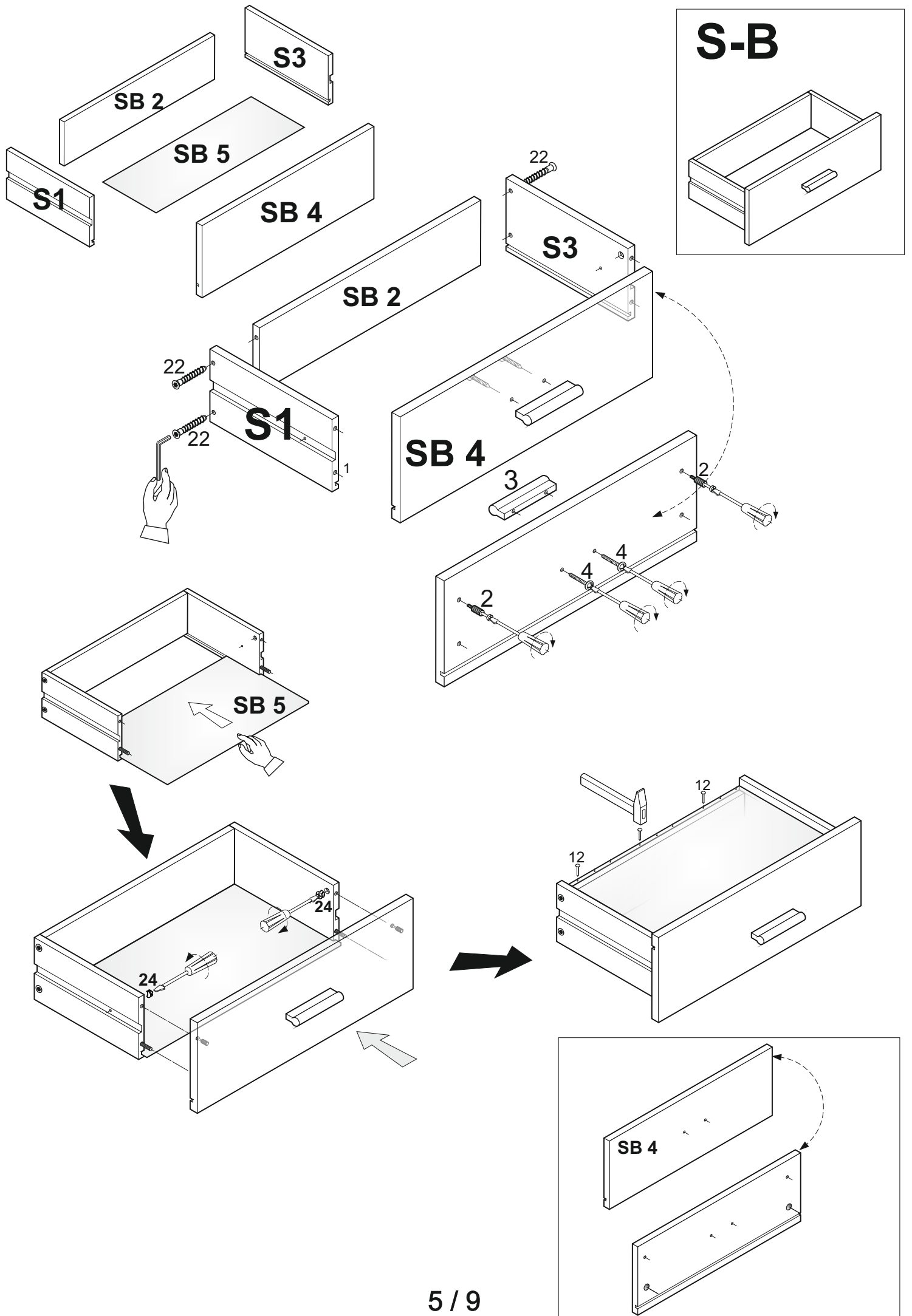

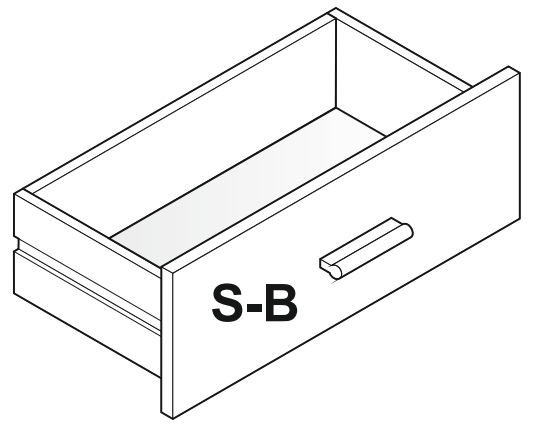
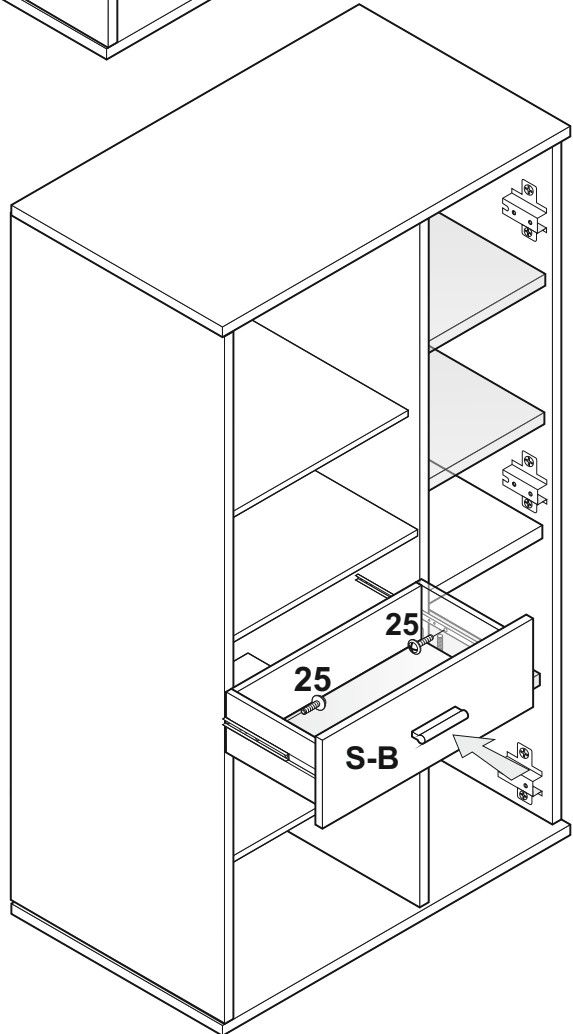
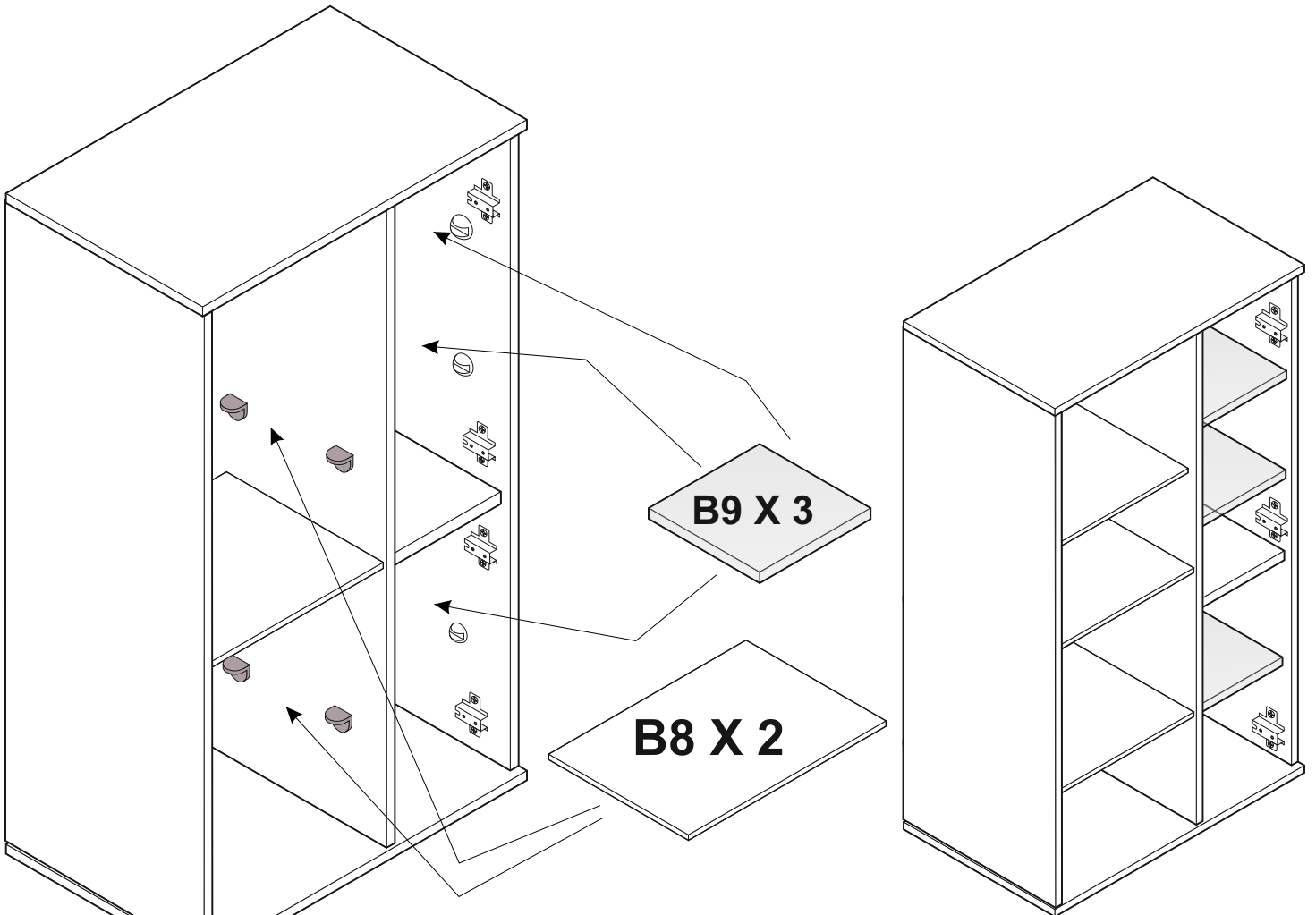

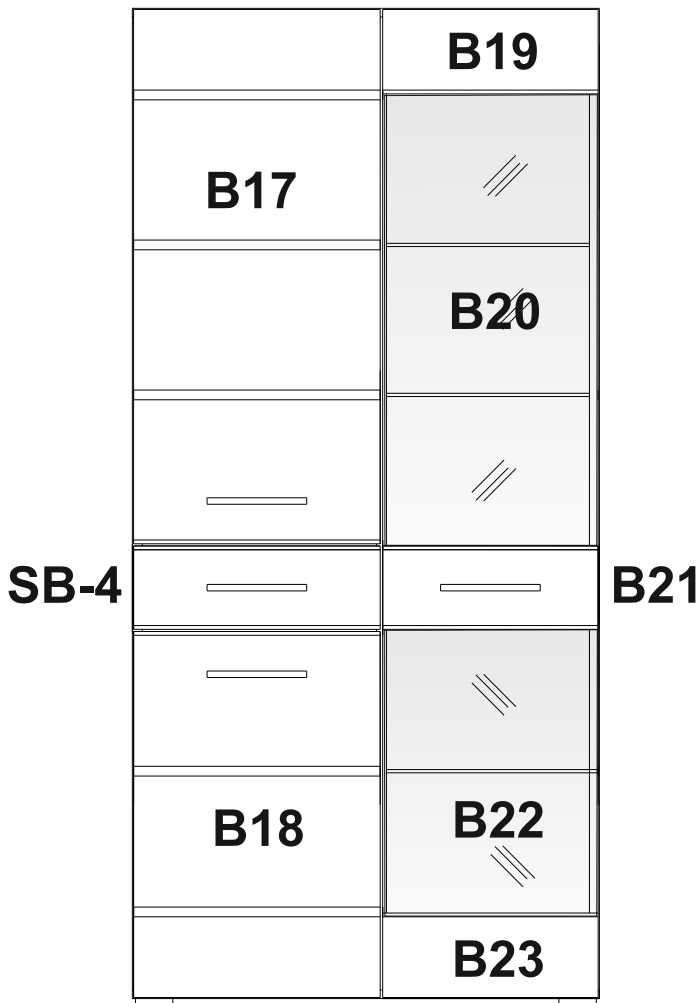
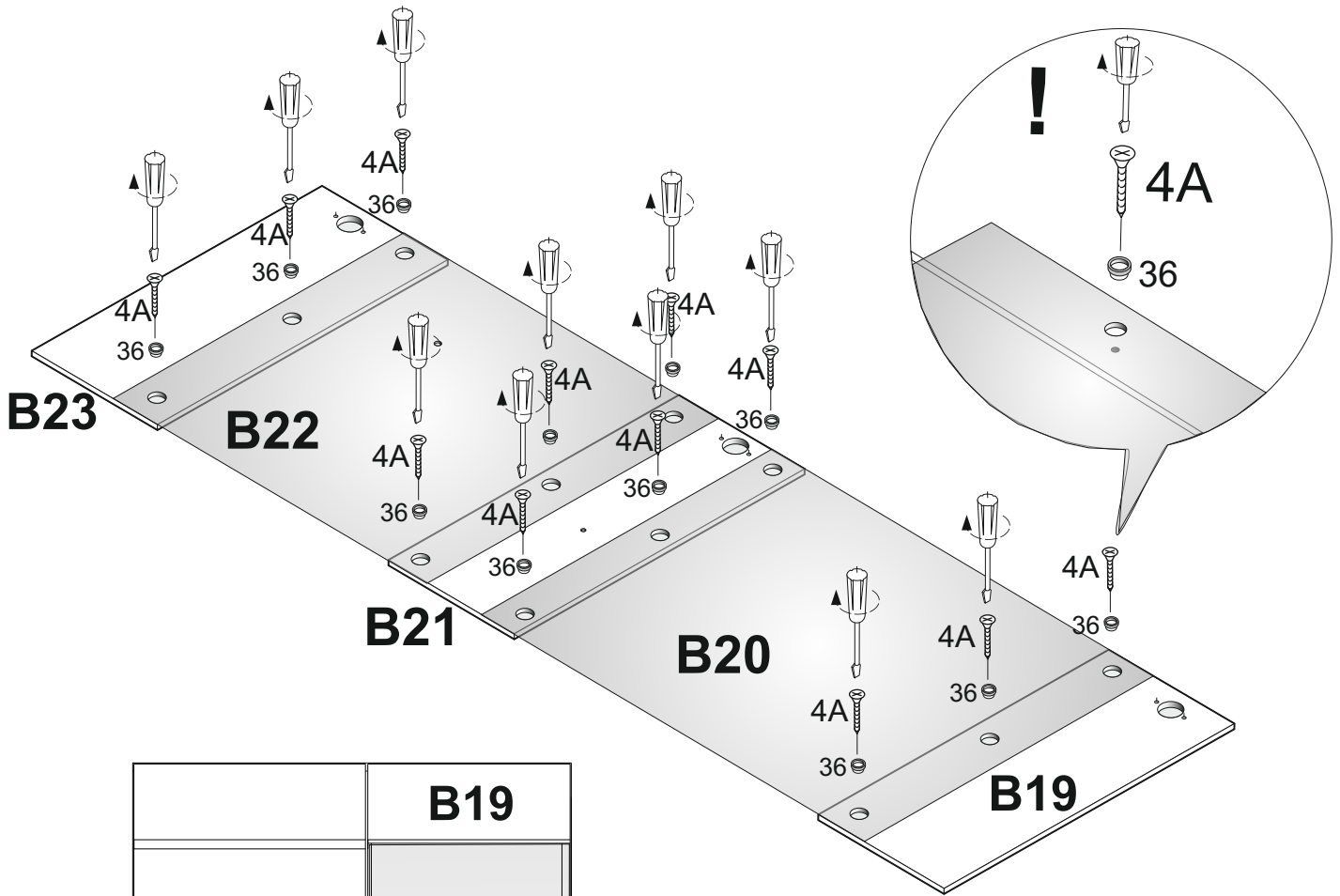

ACHTUNG!
 SCHUTZFOLIE AUF
 DIE FRONTEN. BITTE
 VORSICHTIG ABZIEHEN
 UND 14 TAGE
 DIE FRONTEN
 NICHT PUTZEN, DA DIE
 OBERFLACHE ABHARTEN
 MUSS. SONST WIRD
 DIE FRONT ZERKRATZT!

