

ALEXANDER



HDPE



LDPE

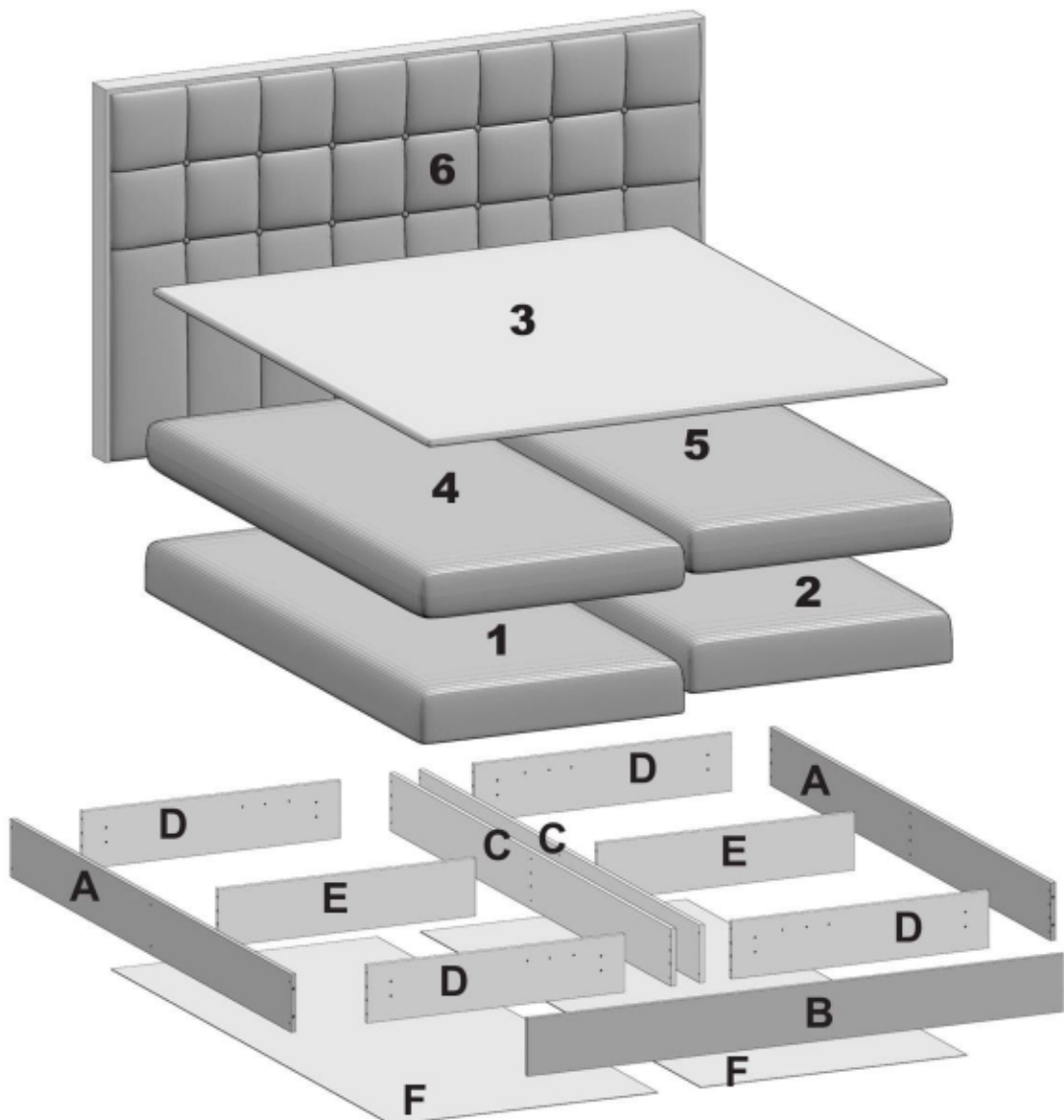

ALEXANDER

1

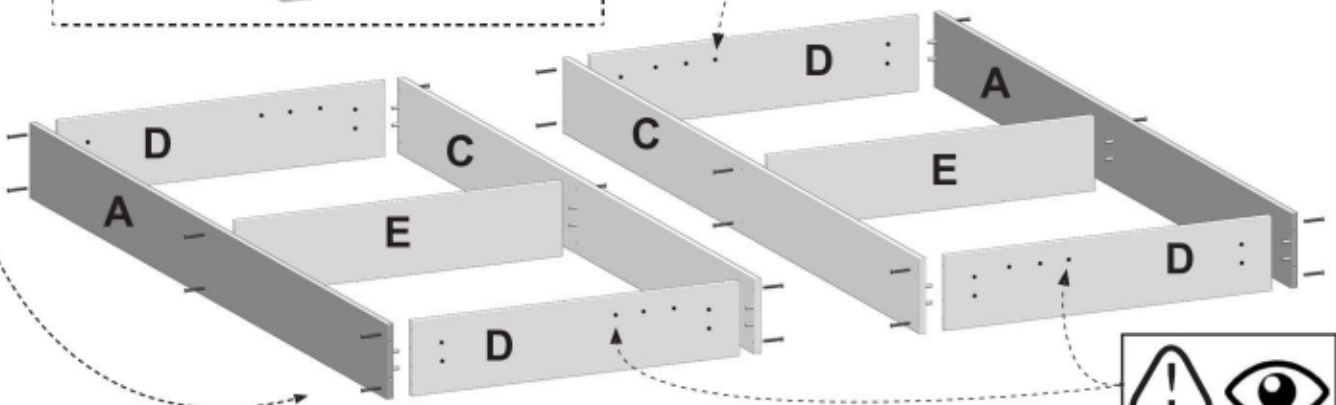
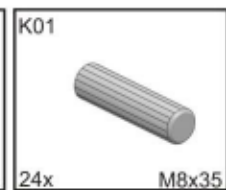
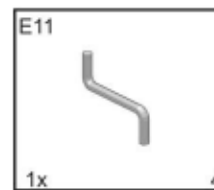
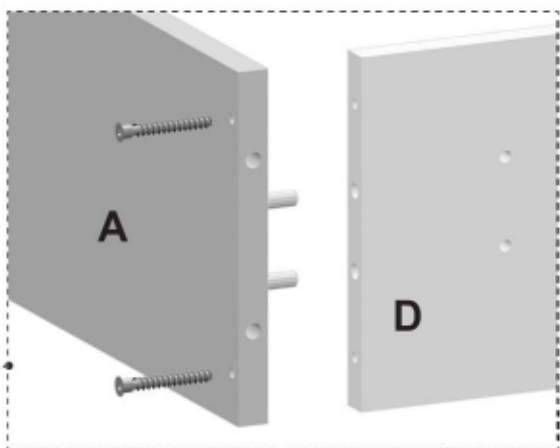

2

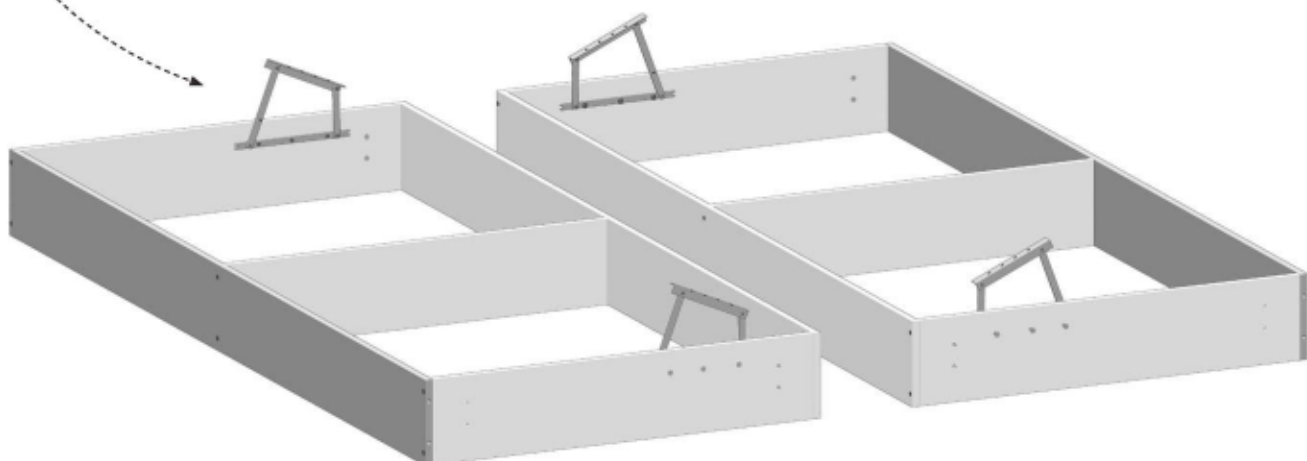
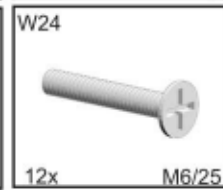
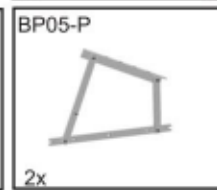
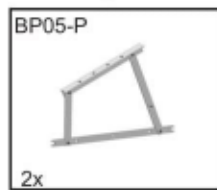
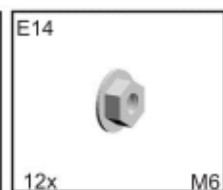
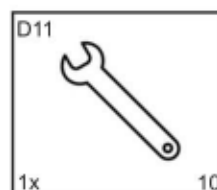
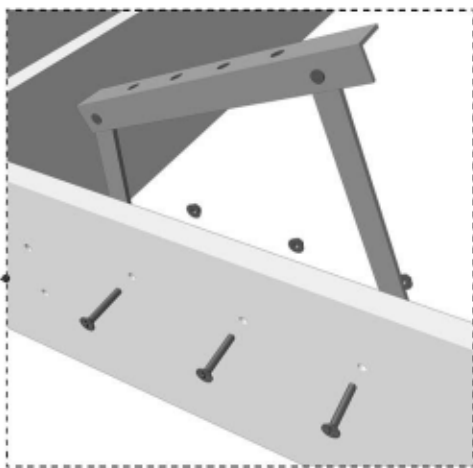

ALEXANDER

3

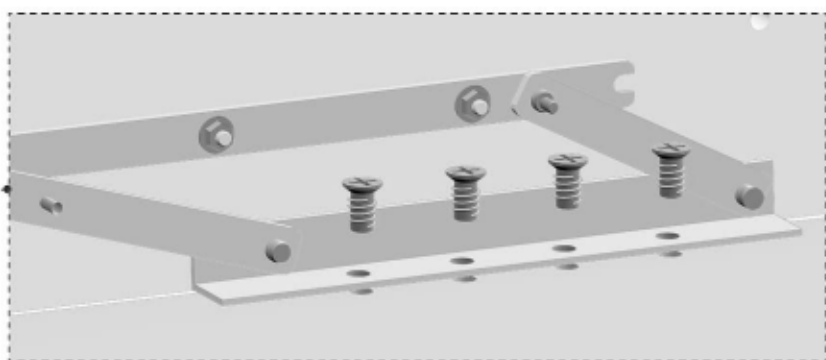

4

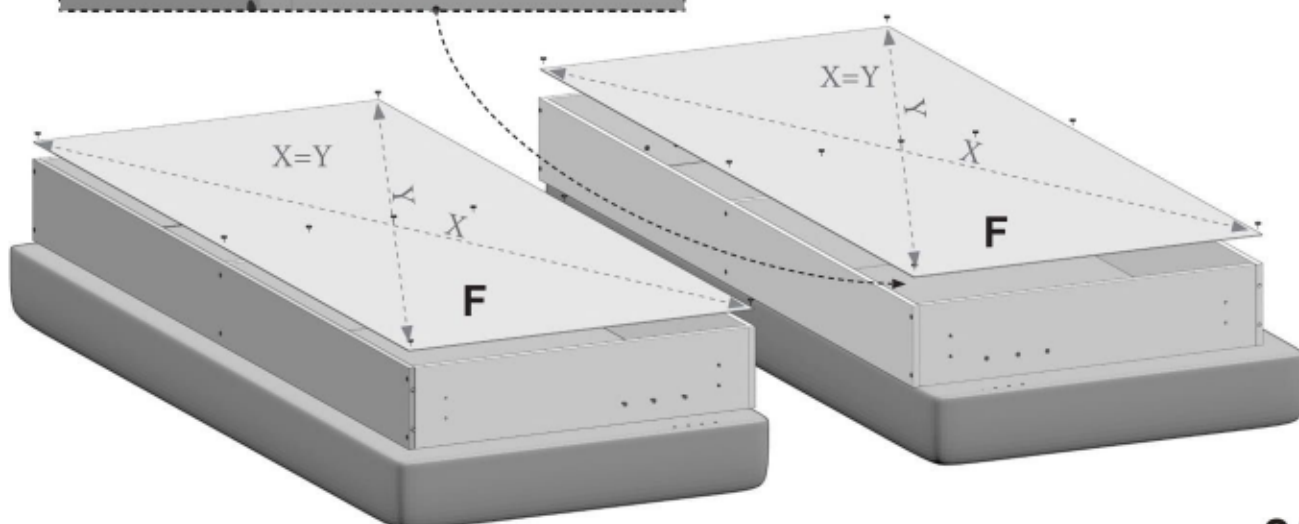
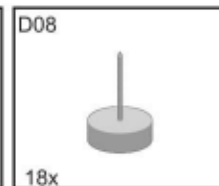
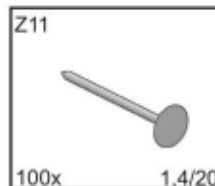
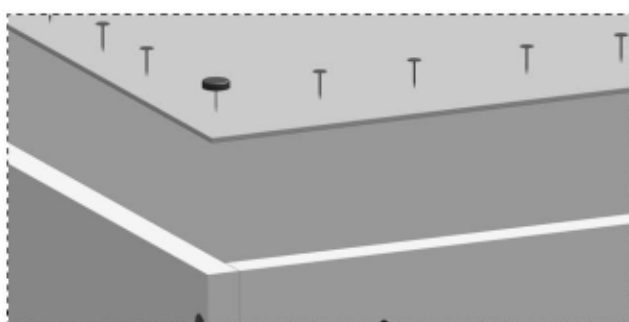

ALEXANDER

5

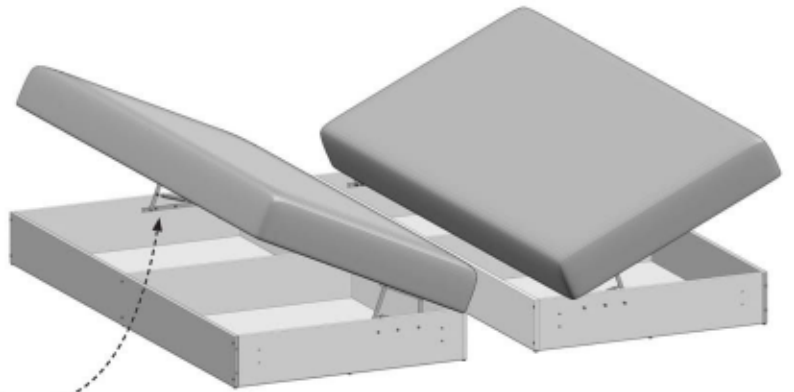
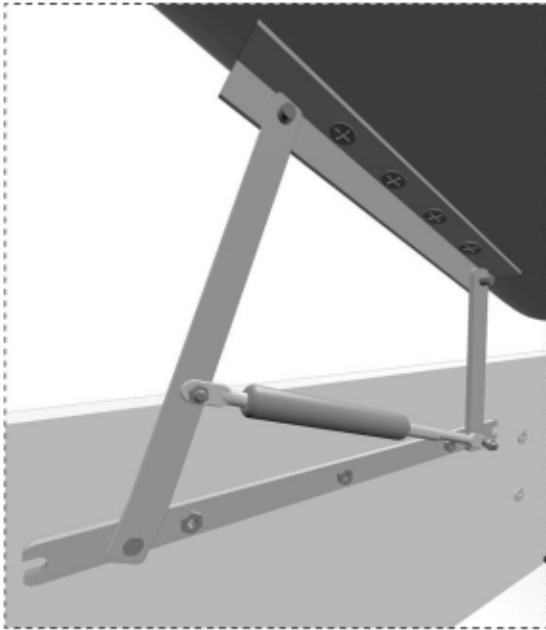

6

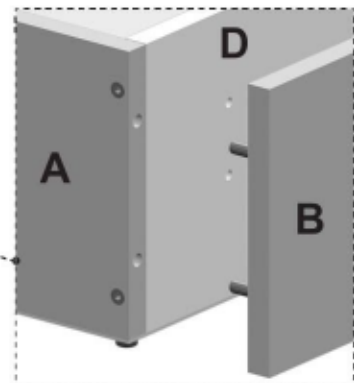
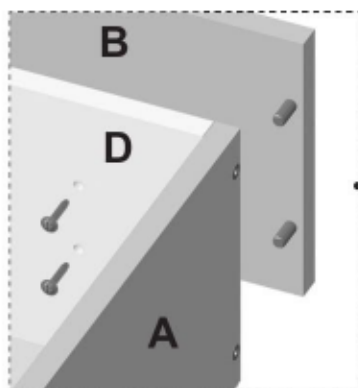
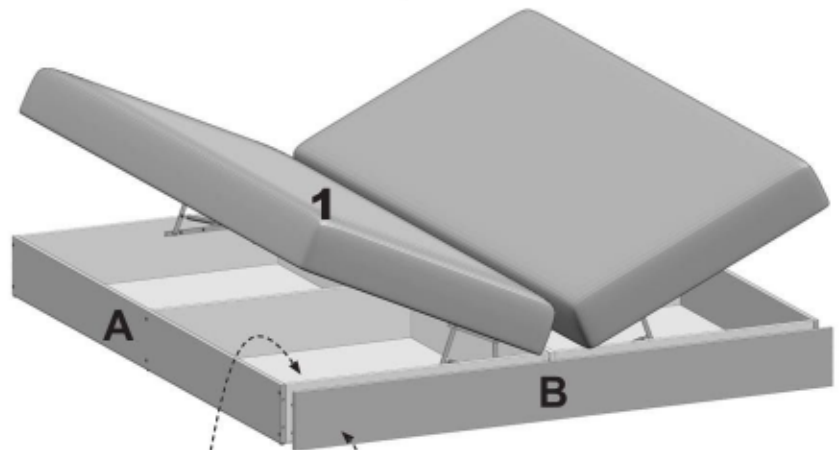
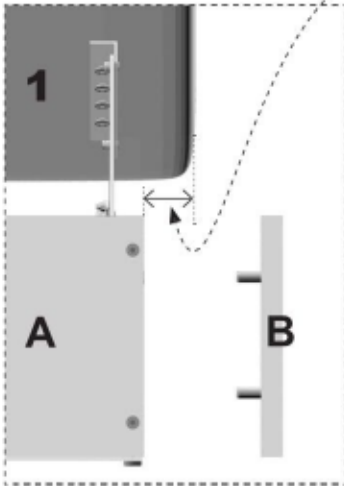
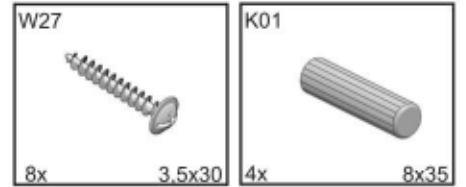

4/6

ALEXANDER

7

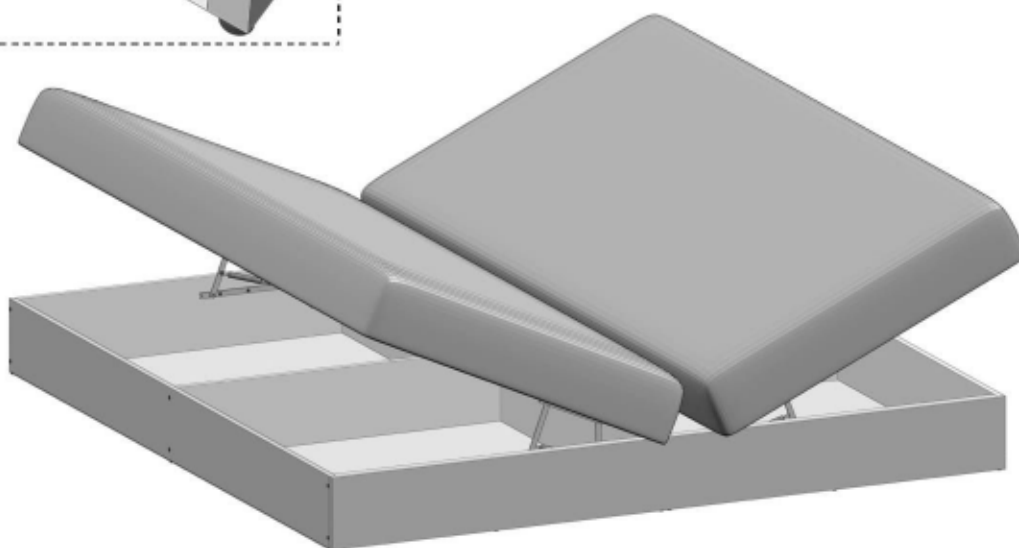
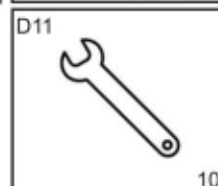
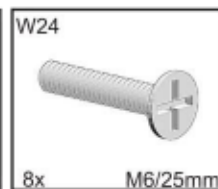
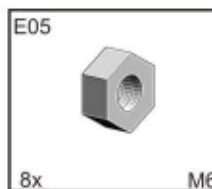
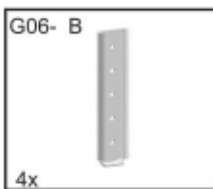
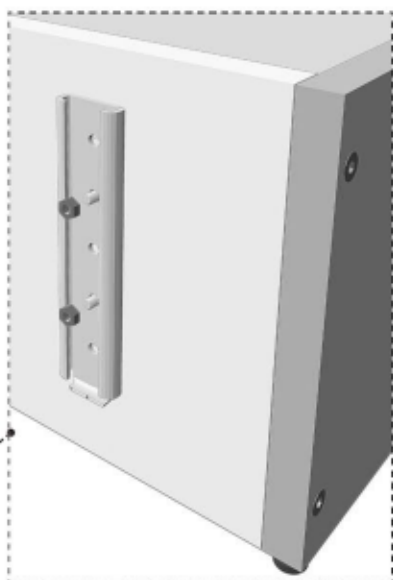

8

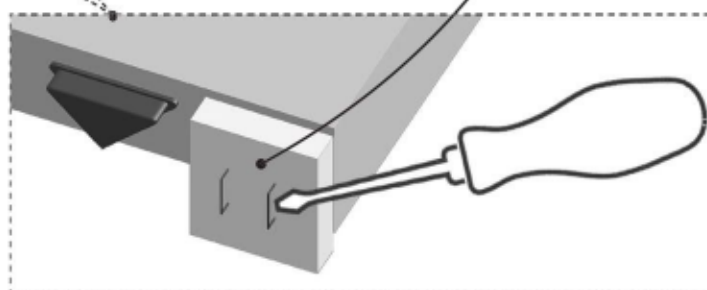
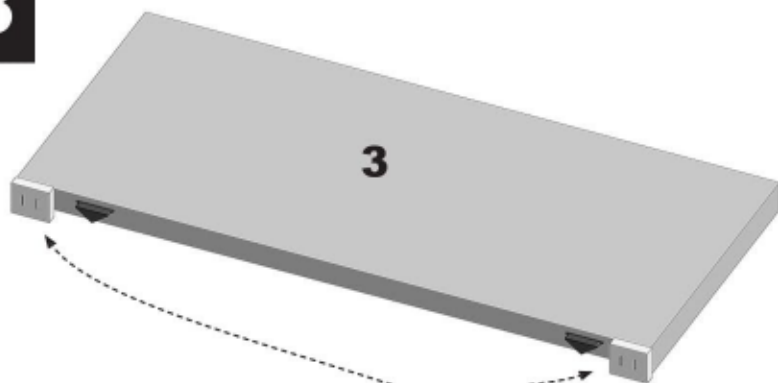

5/6

ALEXANDER

9

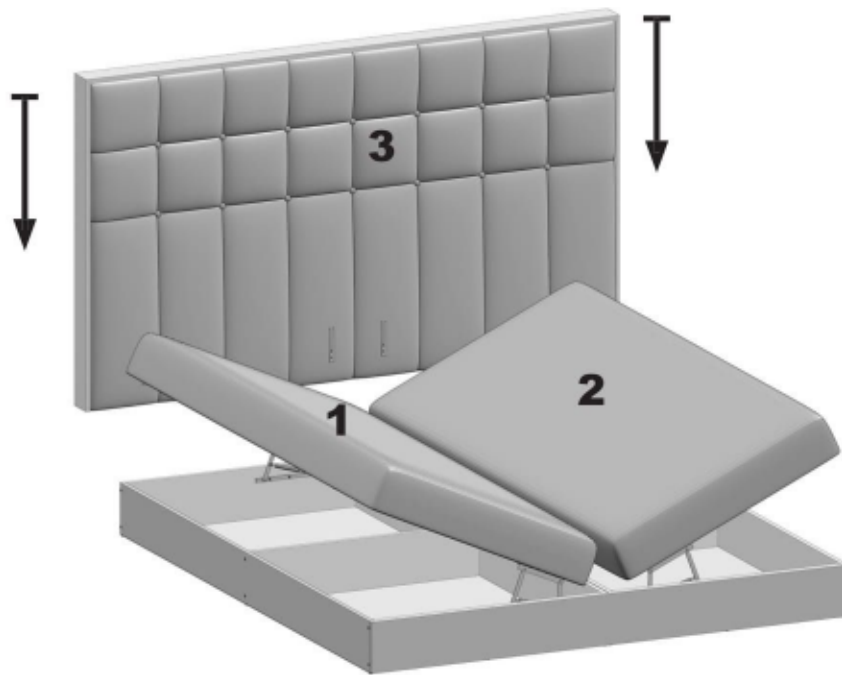

10

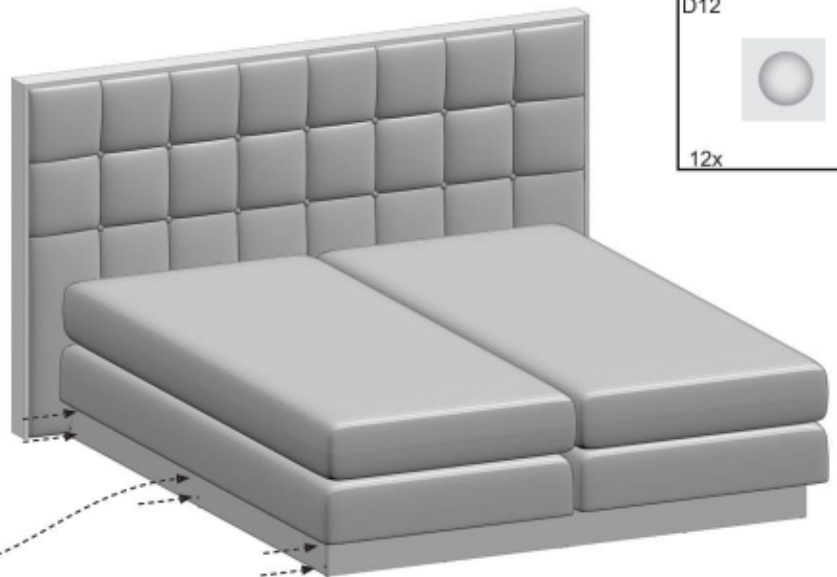
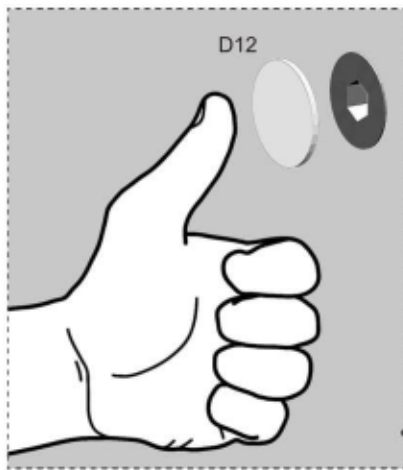

11



12

